

Canon

DIGITAL
**EOS REBEL
XTi**
EOS 400D 
DIGITAL



Exif Print

DPOF

PictBridge

DIRECT
PRINT

BUBBLE JET
DIRECT

INSTRUCTION
MANUAL

Canon

EOS REBEL
XTi

EOS 400D
DIGITAL

INSTRUCTION MANUAL 

Thank you for purchasing a Canon product.

The EOS DIGITAL REBEL XTi/EOS 400D DIGITAL is a high-performance, digital single-lens reflex camera with a 10.10-megapixel imaging sensor. The camera provides many features such as Picture Styles to enhance your photographic expression, fast autofocus for moving subjects, shooting modes for beginners as well as advanced users, and direct printing.

Also, the Self Cleaning Sensor Unit removes dust adhering to the sensor.

Get to know your camera while shooting

This manual explains how to shoot various subjects and scenes for both beginners and advanced users. With a digital camera, you can immediately view the image you have captured. While reading this manual, take pictures as instructed and check the results. This is how you can learn to use the camera and better enjoy photography.

To prevent botched pictures and accidents, read the Safety Warnings (p.10,11) and Handling Precautions (p.12,13).

Test the Camera Before Using

After shooting, playback and check the image whether it has been properly recorded.

If the camera or memory card is faulty and the images cannot be recorded on the card or be read by a personal computer, Canon cannot be held liable.

Copyrights

Copyright laws in your country may prohibit the use of your recorded images of people and certain subjects for anything but private enjoyment. Also be aware that certain public performances, exhibitions, etc., may prohibit photography even for private enjoyment.

Web site to learn and enjoy photography

<http://web.canon.jp/Imaging/enjoydslr/index.html>

Item Check List

Before starting, check that all the following items have been included with your camera. If anything is missing, contact your dealer. The accessories included can also be checked in the System Map (p.164).







- Camera: EOS DIGITAL REBEL XTi/EOS 400D DIGITAL**
(includes eyecup, body cap, and installed battery for the date/time clock)
 - Lens: EF-S18-55mm f/3.5-5.6 II**
(includes lens cap, dust cap) *Lens Kit only.
 - Power Source: Battery Pack NB-2LH** (with protective cover)
 - Charger: Battery Charger CB-2LW/CB-2LWE**
*CB-2LW or CB-2LWE is included.
 - Power Cord for Battery Charger** *For CB-2LWE.
 - 2 Cables**
 - Interface Cable IFC-400PCU**
 - Video Cable VC-100**
 - Strap: EW-100DBII** (with eyepiece cover)
-
- 2 CD-ROMs**
 - EOS DIGITAL Solution Disk** (bundled software)
 - Software Instruction Manual** (PDF)
-
- Pocket Guide**
Quick start guide to shooting.
 - EOS DIGITAL REBEL XTi/EOS 400D DIGITAL Instruction Manual**
(this booklet)
 - Software Guide**
Gives an overview of the bundled software and explains the software installation procedure.
-
- Warranty Card of Camera**
 - Warranty Card of Lens** *Lens Kit only.
-

* Be careful not to lose any of the above items.

* **The CF card (for recording images) is not included.** Please purchase it separately.

Conventions Used in this Manual

Icons in this Manual

- The  icon indicates the Main Dial.
- The  and  icons indicate the cross keys.
- The  icon indicates the SET button.
- ,  or  indicates that the respective function remains active for 4 sec., 6 sec., or 16 sec. respectively after you let go of the button.
- In this manual, the icons and markings indicating the camera's buttons, dials, and settings correspond to the icons and markings on the camera and on the LCD monitor.
- The **MENU** icon indicates a function which can be changed by pressing the <MENU> button and changing the setting.
- The ★ icon on the upper right of the page indicates that the function is available only in the Creative Zone modes (p.20).

About (p.**)

- Indicates the reference page number.

About the Symbols

 : Tip or advice for better shooting.

 : Problem-solving advice.

 : Warning to prevent shooting problems.

 : Supplemental information.

Basic Assumptions

* All operations explained in this manual assume that the power switch is already set to <ON>.

* It is assumed that all the menu settings and Custom Functions are set to the default.

* For explanatory purposes, the instructions show the camera attached with an EF-S18-55mm f/3.5-5.6 II lens.

Contents

Introduction

Item Check List	3
Conventions Used in this Manual	4
Contents at a Glance	8
Handling Precautions	12
Quick Start Guide	14
Nomenclature	16

1 Getting Started 23

Recharging the Battery	24
Installing and Removing the Battery	26
Installing and Removing the CF Card	28
Mounting and Detaching a Lens	30
How to Shoot	31
Switching the LCD Monitor Screen	34
Menu Operations and Settings	35
Before You Start	37

2 Basic Shooting and Image Playback 39

Fully Automatic Shooting	40
Full Auto Techniques	42
Shooting Portraits	43
Shooting Landscapes	44
Shooting Close-ups	45
Shooting Moving Subjects	46
Shooting Portraits at Night	47
Disabling Flash	48
Using the Self-timer	49
Image Playback	50

3 Advanced Shooting Techniques 51

Program AE	52
Changing the ISO Speed	53
Using the Built-in Flash	54
Changing the AF Mode	56
Selecting the AF Point	57
Continuous Shooting	59
Setting the Image-Recording Quality	60
Selecting a Picture Style	63

4	More Advanced Techniques	65
	Action Shots	66
	Changing the Depth of Field.....	68
	Manual Exposure	71
	Automatic Depth-of-Field AE.....	72
	Changing the Metering Mode.....	73
	Setting Exposure Compensation.....	74
	Auto Exposure Bracketing.....	76
	Customizing the Picture Style.....	78
	Defining a New Picture Style.....	81
	Setting the Color Space	83
	AE Lock.....	84
	FE Lock	85
	Setting the White Balance	86
	White Balance Correction.....	88
	Preventing Camera Shake	90
5	Handy Features	93
	Handy Features.....	94
	Silencing the Beeper	94
	CF Card Reminder	94
	Setting the Image Review Time	94
	Set the Auto Power-off Time	95
	Setting the LCD Monitor Brightness.....	95
	File Numbering Method.....	96
	Auto Rotate of Vertical Images.....	98
	Checking Camera Function Settings.....	99
	Reverting the Camera to the Default Settings.....	100
	Preventing the LCD Monitor from Turning off Automatically	101
	Setting Custom Functions	101
	Transferring Images to a Personal Computer	107
	Automatic Sensor Cleaning.....	111
	Appending Dust Delete Data	112
	About "Sensor cleaning: Manual"	114

6	Image Management	115
	Searching for Images Quickly	116
	Magnified View	118
	Rotating the Image	119
	Auto Playback	120
	Displaying the Images on TV	121
	Protecting Images	122
	Erasing Images	123
	Shooting Information Display	124
7	Printing Images	127
	Preparing to Print	129
	Printing with PictBridge	132
	Printing with CP Direct and BJ Direct	139
	Trimming the Image	142
	Easy Printing	143
	Print Ordering	144
	Direct Printing with DPOF	149
8	Reference	151
	External Speedlites	152
	Wireless Remote Control	153
	Using a Household Power Outlet	154
	Replacing the Date/Time Battery	155
	Menu Settings	156
	Function Availability Table	158
	When Autofocus Fails	160
	Troubleshooting Guide	161
	Error Codes	163
	System Map	164
	Specifications	166
	Index	176



Contents at a Glance

Shooting

- **Shoot automatically** → p.39 - 48 (Basic Zone modes)
- **Shoot continuously** → p.43, 46, 59 (📷 Continuous shooting)
- **Take a picture of myself in a group** → p.49 (🕒 Self-timer)
- **Freeze the action**
- **Take a blurred action shot** → p.66 (Tv Shutter-priority AE)
- **Blur the background**
- **Keep the background in sharp focus**
→ p.68 (Av Aperture-priority AE)
- **Adjust the image brightness (exposure)**
→ p.74 (Exposure compensation)
- **Shoot under low light** → p.40, 54 (Flash photography)
- **Shoot without flash** → p.48 (🚫 Flash Off)
- **Photograph fireworks at night** → p.71 (Bulb exposure)

Image Quality

- **Change the image effects** → p.63 (Selecting a Picture Style)
- **Make a large size print of the picture** → p.60 (📐L, 📐L, RAW)
- **Take many pictures** → p.60 (📐S, 📐S)
- **Take black-and-white or sepia photos** → p.64 (Monochrome)





Focusing

- **Change the point of focus** → **p.57** (AF point selection)
- **Select the AF point quickly** → **p.103** (C.Fn-1-4)
- **Shoot a moving subject** → **p.46, 56** (AI Servo AF)

Playback

- **View the images with the camera** → **p.50** (Playback)
- **Search for pictures quickly** → **p.116** (Index display)
- **Prevent important images from accidental deletion**
→ **p.122** (Image protect)
- **Delete unnecessary images** → **p.123** (Delete)
- **View the images on a TV set** → **p.121** (Video OUT)
- **Set the LCD brightness** → **p.95** (LCD Brightness)

Printing

- **Print pictures easily** → **p.127** (Direct printing)



Safety Warnings

Follow these safeguards and use the equipment properly to prevent injury, death, and material damage.

Preventing Serious Injury or Death

- To prevent fire, excessive heat, chemical leakage, and explosions, follow the safeguards below:
 - Do not use any batteries, power sources, and accessories not specified in this booklet. Do not use any home-made or modified batteries.
 - Do not short-circuit, disassemble, or modify the battery pack or back-up battery. Do not apply heat or apply solder to the battery pack or back-up battery. Do not expose the battery pack or back-up battery to fire or water. And do not subject the battery pack or back-up battery to strong physical shock.
 - Do not install the battery pack or back-up battery in reversed polarity (+ -). Do not mix new and old or different types of batteries.
 - Do not recharge the battery pack outside the allowable ambient temperature range of 0°C - 40°C (32°F - 104°F). Also, do not exceed the recharging time.
 - Do not insert any foreign metallic objects into the electrical contacts of the camera, accessories, connecting cables, etc.
- Keep the back-up battery away from children. If a child swallows the battery, consult a physician immediately. (Battery chemicals may harm the stomach and intestines.)
- When disposing of a battery pack or back-up battery, insulate the electrical contacts with tape to prevent contact with other metallic objects or batteries. This is to prevent fire or an explosion.
- If excessive heat, smoke, or fumes are emitted during battery pack recharging, immediately unplug the battery charger from the power outlet to stop the recharging and prevent a fire.
- If the battery pack or back-up battery leaks, changes color, deforms, or emits smoke or fumes, remove it immediately. Be careful not to get burned in the process.
- Prevent any battery leakage from contacting your eyes, skin, and clothing. It can cause blindness or skin problems. If the battery leakage contacts your eyes, skin, or clothing, flush the affected area with lots of clean water without rubbing it. See a physician immediately.
- During the recharging, keep the equipment away from the reach of children. The cord can accidentally choke the child or give an electrical shock.
- Do not leave any cords near a heat source. It can deform the cord or melt the insulation and cause a fire or electrical shock.
- Do not fire the flash at someone driving a car. It may cause an accident.
- Do not fire the flash near a person's eyes. It may impair the person's vision. When using flash to photograph an infant, keep at least 1 meter away.
- Before storing the camera or accessory when not in use, remove the battery pack and disconnect the power plug. This is to prevent electrical shock, heat generation, and fire.
- Do not use the equipment where there is flammable gas. This is to prevent an explosion or fire.

-
- If you drop the equipment and the casing breaks open to expose the internal parts, do not touch the internal parts due to the possibility of electrical shock.
 - Do not disassemble or modify the equipment. High-voltage internal parts can cause electrical shock.
 - Do not look at the sun or an extremely bright light source through the camera or lens. Doing so may damage your vision.
 - Keep the camera from the reach of small children. The neck strap can accidentally choke the child.
 - Do not store the equipment in dusty or humid places. This is to prevent fire and electrical shock.
 - Before using the camera inside an airplane or hospital, check if it is allowed. Electromagnetic waves emitted by the camera may interfere with the plane's instruments or the hospital's medical equipment.
 - To prevent fire and electrical shock, follow the safeguards below:
 - Always insert the power plug all the way in.
 - Do not handle a power plug with wet hands.
 - When unplugging a power plug, grasp and pull the plug instead of the cord.
 - Do not scratch, cut, or excessively bend the cord or put a heavy object on the cord. Also do not twist or tie the cords.
 - Do not connect too many power plugs to the same power outlet.
 - Do not use a cord whose insulation has been damaged.
 - Occasionally unplug the power plug and use a dry cloth to clean off the dust around the power outlet. If the surrounding is dusty, humid, or oily, the dust on the power outlet may become moist and short-circuit the outlet to cause a fire.
-

Preventing Injury or Equipment Damage

- Do not leave equipment inside a car under the hot sun or near a heat source. The equipment may become hot and cause skin burns.
- Do not carry the camera around while it is attached to a tripod. Doing so may cause injury. Also make sure the tripod is sturdy enough to support the camera and lens.
- Do not leave a lens or lens-attached camera under the sun without the lens cap attached. Otherwise, the lens may concentrate the sun's rays and cause a fire.
- Do not cover or wrap the battery-recharging apparatus with a cloth. Doing so may trap heat within and cause the casing to deform or catch fire.
- If you drop the camera in water or if water or metal fragments enter inside the camera, promptly remove the battery pack and back-up battery. This is to prevent fire and electrical shock.
- Do not use or leave the battery pack or back-up battery in a hot environment. Doing so may cause battery leakage or a shorter battery life. The battery pack or back-up battery can also become hot and cause skin burns.
- Do not use paint thinner, benzene, or other organic solvents to clean the equipment. Doing so may cause fire or a health hazard.

If the product does not work properly or requires repair, contact your dealer or your nearest Canon Service Center.

Handling Precautions

Camera Care

- This camera is a precision instrument. Do not drop it or subject it to physical shock.
- The camera is not waterproof and cannot be used underwater. If you accidentally drop the camera into water, promptly consult your nearest Canon Service Center. Wipe off any water droplets with a dry cloth. If the camera has been exposed to salty air, wipe with a well-wrung wet cloth.
- Never leave the camera near anything having a strong magnetic field such as a magnet or electric motor. Also avoid using or leaving the camera near anything emitting strong radio waves such as a large antenna. Strong magnetic fields can cause camera misoperation or destroy image data.
- Do not leave the camera in excessive heat such as in a car in direct sunlight. High temperatures can cause the camera to malfunction.
- The camera contains precision electronic circuitry. Never attempt to disassemble the camera yourself.
- Use a blower to blow away dust on the lens, viewfinder, reflex mirror, and focusing screen. Do not use cleaners that contain organic solvents to clean the camera body or lens. For stubborn dirt, take the camera to the nearest Canon Service Center.
- Do not touch the camera's electrical contacts with your fingers. This is to prevent the contacts from corroding. Corroded contacts can cause camera misoperation.
- If the camera is suddenly brought in from the cold into a warm room, condensation may form on the camera and internal parts. To prevent condensation, first put the camera in a sealed plastic bag and let it adjust to the warmer temperature before taking it out of the bag.
- If condensation forms on the camera, do not use the camera. This is to avoid damaging the camera. If there is condensation, remove the lens, CF card and battery from the camera, and wait until the condensation has evaporated before using the camera.
- If the camera will not be used for an extended period, remove the battery and store the camera in a cool, dry, well-ventilated location. Even while the camera is in storage, press the shutter button a few times once in a while to check that the camera is still working.
- Avoid storing the camera where there are corrosive chemicals such as a darkroom or chemical lab.
- If the camera has not been used for an extended period, test all its functions before using the camera. If you have not used the camera for some time or if there is an important shoot coming up, have the camera checked by your Canon dealer or check the camera yourself and make sure it is working properly.

LCD Monitor

- Although the LCD monitor is manufactured with very high precision technology with over 99.99% effective pixels, there might be a few dead pixels among the remaining 0.01% or less pixels. Dead pixels displaying only black or red, etc., are not a malfunction. They do not affect the images recorded.
- If the LCD monitor is left on for a prolonged period, screen burn-in may occur where you see remnants of what was displayed. However, this is only temporarily and will disappear when the camera is left unused for a few days.

CF Card

- The CF card is a precision device. Do not drop the CF card or subject it to vibration. Doing so could damage the images recorded on them.
- Do not store or use the CF card near anything having a strong magnetic field such as a TV set, speakers, or magnet. Also avoid places prone to having static electricity. Otherwise, the images recorded on the CF card might be lost.
- Do not leave the CF card in direct sunlight or near a heat source. Doing so can warp the cards and make them unusable.
- Do not spill any liquid onto the CF card.
- Always store your CF cards in a case to protect the data stored on them.
- Do not bend the card or subject it to any excessive force or physical shock.
- Do not store the CF card in hot, dusty, or humid locations.

Lens Electrical Contacts

After detaching the lens from the camera, attach the lens caps or put down the lens with the rear end up to avoid scratching the lens surface and electrical contacts.

Contacts



Quick Start Guide

1

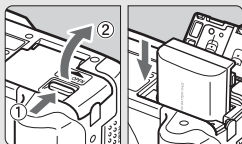

Insert the battery. (p.26)

To recharge the battery, see page 24.

2

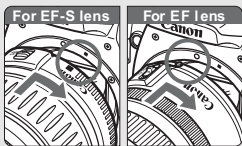

Attach the lens. (p.30)

When attaching an EF-S lens, align it with the white index on the camera.
For other lenses, align it with the red index.

3

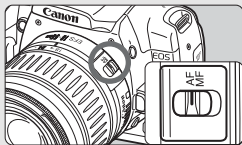

Set the lens focus mode switch to <AF>. (p.30)

4

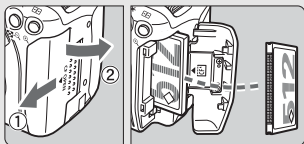

Open the CF card slot cover and insert a CF card. (p.28)

Face the label side toward you and insert the end with the small holes into the camera.

5

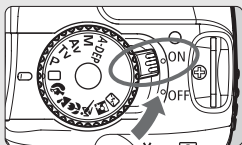

Set the power switch to <ON>. (p.31)

► The current camera settings appear on the LCD monitor.

6



Set the Mode Dial to \square (Full Auto). (p.40)

All the necessary camera settings will be set automatically.

7



Focus the subject. (p.33)

Look through the viewfinder and aim the viewfinder center over the subject. Press the shutter button halfway, and the camera will focus the subject.

8

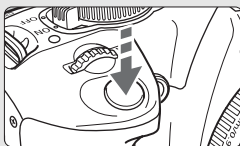

Take the picture. (p.33)

Press the shutter button completely to take the picture.

9



Review the picture on the LCD monitor. (p.94)

The captured image will be displayed for about 2 sec. on the LCD monitor.

- The camera setting display on the LCD monitor turns off automatically when you put your eye near the eyepiece.
- To view images captured so far, see “Image Playback” (p.50).
- To delete an image, see “Erasing Images” (p.123).

Nomenclature

The parts indicated in bold are used up to the “Basic Shooting and Image Playback” section.

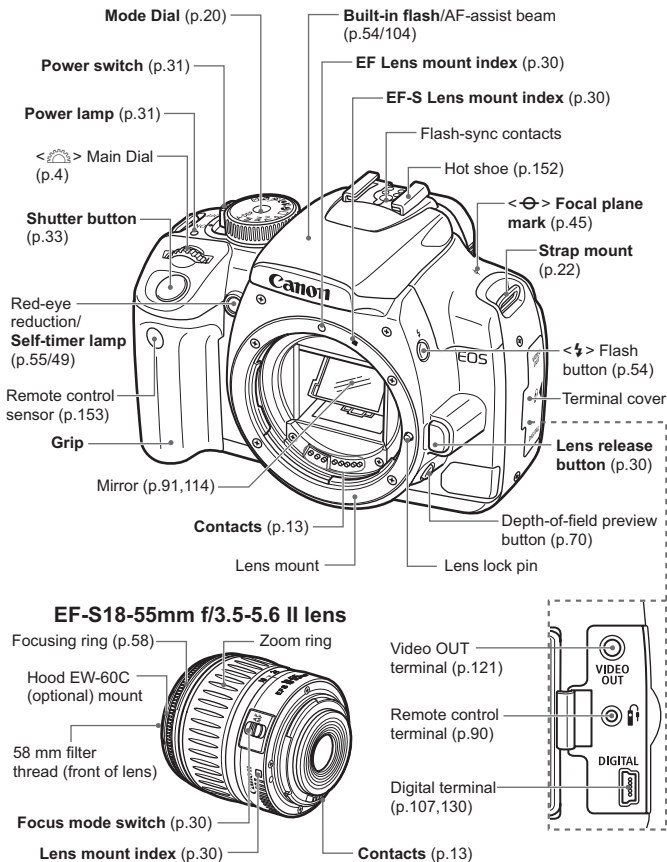

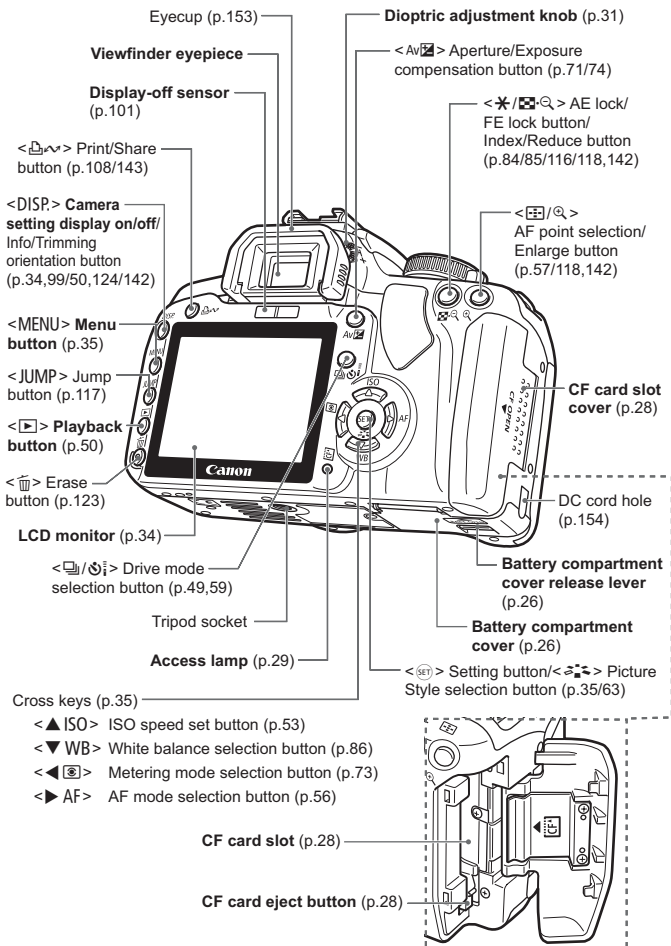

Camera Setting Display

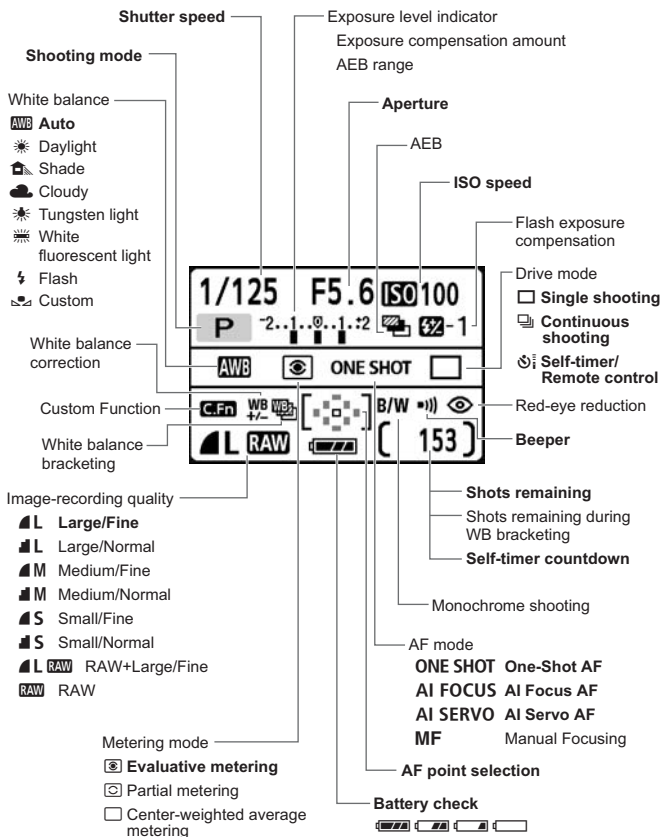

The display will show only the settings currently applicable.

Viewfinder Information

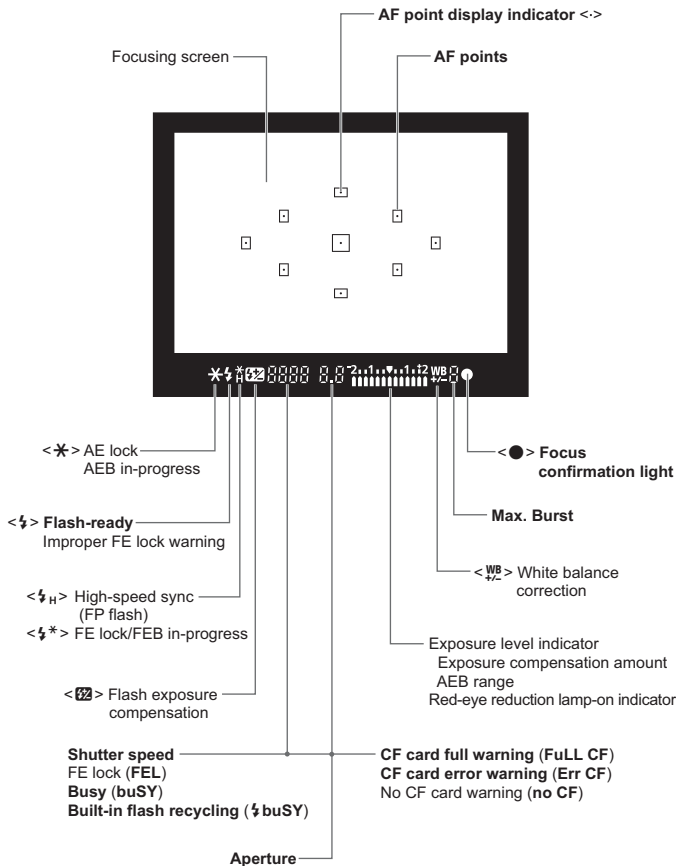

The display will show only the settings currently applicable.

Mode Dial

The Mode Dial has the Basic Zone modes and Creative Zone modes.

Creative Zone

These modes give you more control over the result.

- P** : Program AE (p.52)
- Tv** : Shutter-priority AE (p.66)
- Av** : Aperture-priority AE (p.68)
- M** : Manual exposure (p.71)
- A-DEP** : Automatic Depth-of-field AE (p.72)

Full Auto

Basic Zone

All you do is press the shutter button. Fully automatic shooting for specific kinds of subjects.

-  : **Full Auto** (p.40)

Image Zone

-  : Portrait (p.43)
-  : Landscape (p.44)
-  : Close-up (p.45)
-  : Sports (p.46)
-  : Night Portrait (p.47)
-  : Flash Off (p.48)

Battery Charger CB-2LW

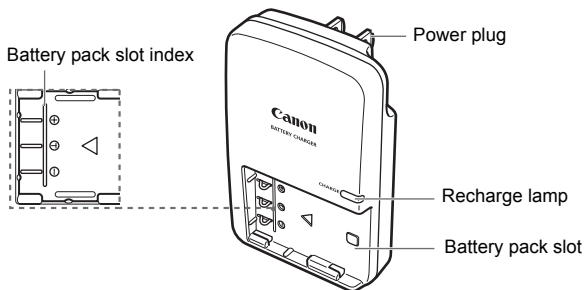

This power unit is intended to be correctly orientated in a vertical or floor mount position.

Battery Charger CB-2LWE

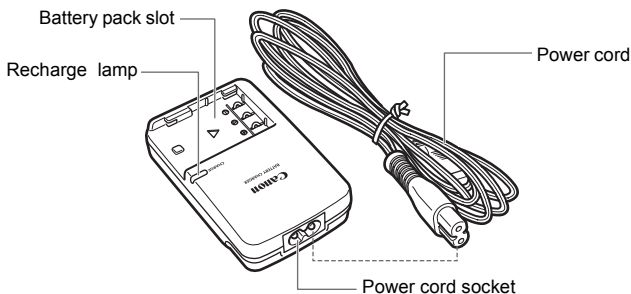

Do not use any AC adapters or compact power adapters other than the ones (rated input: 100-240 V AC, 50/60 Hz, rated output: 7.8-8.1 V DC) shown on the system map (p.164). Using such incompatible adapters may result in fire, overheating, or electrical shock.

Attaching the Strap

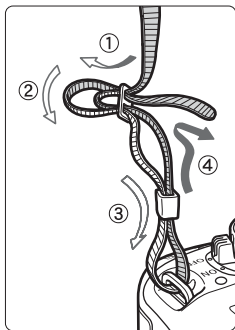

Pass the end of the strap through the camera's strap mount eyelet from the bottom. Then pass it through the strap's buckle as shown in the illustration. Pull the strap to take up any slack and make sure the strap will not loosen from the buckle.

- The eyepiece cover is also attached to the strap. (p.153)

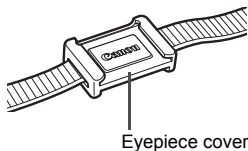

- Adobe is a trademark of Adobe Systems Incorporated.
- CompactFlash is a trademark of SanDisk Corporation.
- Windows is a trademark or registered trademark of Microsoft Corporation in the United States and other countries.
- Macintosh is a registered trademark of Apple Corporation in the United States and other countries.
- All other corporate and product names and trademarks mentioned in this manual are the property of their respective owners.

* This digital camera supports Design rule for Camera File System 2.0 and Exif 2.21 (also called "Exif Print"). Exif Print is a standard that enhances compatibility between digital cameras and printers. By connecting to an Exif Print-compliant printer, the shooting information is incorporated to optimize the print output.

1

Getting Started

This chapter explains preliminary steps and basic camera operations.

Recharging the Battery

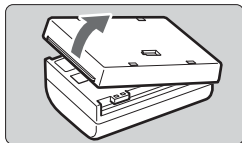

1 Remove the cover.

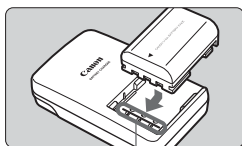

Battery pack slot index

2 Attach the battery.

- Align the battery's front edge with the battery charger's index line. While pressing down the battery, slide it in the direction of the arrow.
- To detach the battery, follow the above procedure in reverse.

CB-2LW

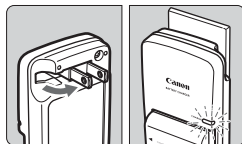

3 For CB-2LW

Flip out the prongs and recharge the battery.

- As shown by the arrow, flip out the battery charger's prongs.
- Insert the prongs into a power outlet.

CB-2LWE

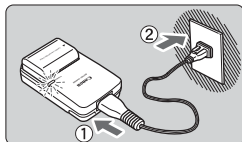



For CB-2LWE

Connect the power cord and recharge the battery.

- Connect the power cord to the charger and insert the plug into the power outlet.
- ▶ Recharging starts automatically and the recharge lamp turns orange.
- ▶ When the battery is fully recharged, the recharge lamp will turn green.
- **It takes about 90 minutes to fully recharge a completely exhausted battery.**



Tips for Using the Battery and Charger

- **Recharge the battery on the day before or on the day it is to be used.**
An unused charged battery will still gradually lose its power over time. The time required to recharge the battery depends on the ambient temperature and battery's power level.
 - **Do not recharge the battery for longer than 24 hours** (to avoid degrading the battery performance).
 - **After recharging the battery, detach it and unplug the charger from the power outlet.**
 - **You can attach the cover in a different orientation to indicate whether the battery has been recharged or not.**
If the battery has been recharged, attach the cover so that the battery-shaped hole <  > is aligned over the blue seal on the battery. If the battery is exhausted, attach the cover in the opposite orientation.
 
 - **Use the battery in an ambient temperature range of 0°C - 40°C / 32°F - 104°F.**
To attain best battery performance, an ambient temperature of 10°C - 30°C / 50°F - 86°F is recommended. In cold locations such as snowy areas, battery performance and operation time may temporarily decrease.
 - **When not using the camera, remove the battery.**
If the battery is left in the camera for a prolonged period, a small amount of power current is released, resulting in excess discharge and shorter battery life. Store the battery with the cover attached. Storing the battery after it is fully charged can lower the battery's performance.
 - **The battery charger can also be used in foreign countries.**
The battery charger is compatible with a 100 V AC to 240 V AC 50/60 Hz power source. If the shape of the prongs is different, purchase a plug adapter for that country. Do not attach any voltage transformer to the battery charger. Doing so can damage the battery charger.
 - **If the battery becomes exhausted quickly even after being fully charged, replace the battery.**
Replace the battery with a new one.
- Do not use the battery charger to recharge any battery other than Battery Pack NB-2LH.
 - Battery Pack NB-2LH is dedicated to Canon only. Using it with a non-Canon battery charger or product may result in malfunction or accidents for which Canon cannot be held liable.

Installing and Removing the Battery

Installing the Battery

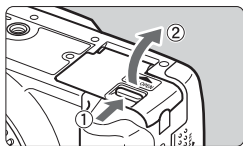

1 Open the battery compartment cover.

- Slide the lever as shown by the arrow and open the cover.

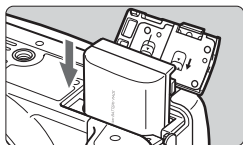

2 Insert the battery.

- Insert the end with the battery contacts.
- Insert the battery until it locks in place.

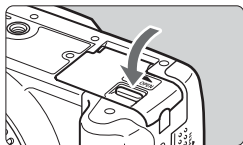

3 Close the cover.

- Press the cover until it snaps shut.

Checking the Battery Level

When the power switch is set to <ON> (p.31), the battery level will be displayed:



 : Battery level OK.

 : Battery level is slightly down, but adequate power remains.

 : Battery will be exhausted soon.

 : Battery must be recharged.

Battery Life

[Approx. number of shots]

Temperature	Shooting Conditions	
	No Flash	50% Flash Use
At 23°C / 73°F	500	360
At 0°C / 32°F	370	280

- The figures above are based on a fully-charged NB-2LH and CIPA (Camera & Imaging Products Association) testing criteria.

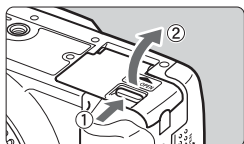

- The actual number of shots may be fewer than indicated above depending on the shooting conditions.
- Pressing the shutter button halfway for long periods or operating only the autofocus can also reduce the number of possible shots.
- The lens operation is powered by the camera's battery. Using certain lenses can reduce the number of possible shots.

Removing the Battery**1 Open the battery compartment cover.**

- Slide the lever as shown by the arrow and open the cover.

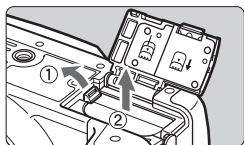
**2 Remove the battery.**

- Slide the battery lock lever as shown by the arrow and remove the battery.
- To prevent shorting, be sure to attach the protective cover to the battery.

Installing and Removing the CF Card

The captured image is recorded onto the CF card (optional). Although the thickness is different between the Type I and Type II CF cards, either one can be inserted into the camera. The camera is also compatible with Microdrive (hard disk-type) and CF cards with 2 GB or higher capacity.

Installing the Card

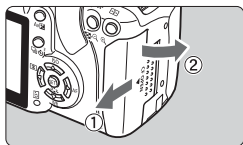

1 Open the cover.

- Slide the cover as shown by the arrow to open it.

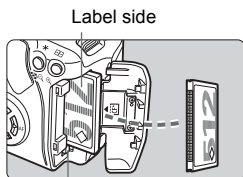

2 Insert the CF card.

- As shown in the illustration, face the label side toward you and insert the end with the small holes into the camera.

Inserting the CF card in the wrong way may damage the camera.

- ▶ The CF card eject button will stick up.

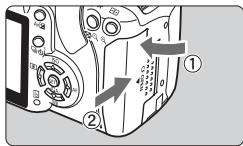

3 Close the cover.

- Close the cover and slide it in the direction shown by the arrow until it snaps shut.

- When you set the power switch to <ON>, the number of remaining shots will be displayed on the LCD monitor.

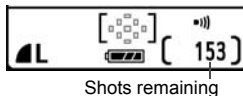

The shots remaining depends on the remaining capacity of the CF card, image recording quality, ISO speed, etc.

Removing the Card

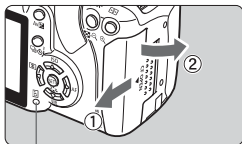

Access lamp

1 Open the cover.

- Set the power switch to <OFF>.
- Check that “Recording...” is not displayed on the LCD monitor.
- Make sure the access lamp is off, then open the cover.

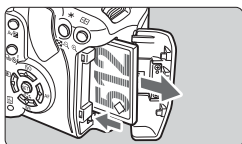

2 Remove the CF card.

- Press the CF card eject button.
- ▶ The CF card will come out.
- Close the cover.



- **A blinking access lamp indicates that data is being transferred, read, written, or erased on the CF card. While the access lamp is lit or blinking, do not do any of the following. Doing so may damage the image data. It may also damage the CF card or camera.**
 - Opening the CF card slot cover.
 - Removing the battery.
 - Shaking or banging the camera around.
- If the CF card already contains recorded images, the image number might not start from 0001. (p.96)
- If a CF card-related error is displayed, see page 38.
- Compared to CF cards, hard disk-type memory cards are more vulnerable to vibration and physical shock. If you use a such a card, be careful not to subject the camera to vibration or physical shock especially while recording or displaying images.



On the menu, if you set [**Shoot w/o card**] to [**Off**], it will prevent shooting without a CF card. (p.94)

Mounting and Detaching a Lens

Mounting a Lens

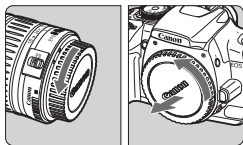

1 Remove the caps.

- Remove the rear lens cap and the body cap by turning them as shown by the arrow.

EF-S lens mount index

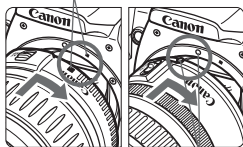

EF lens mount index

2 Attach the lens.

- Align the EF-S lens with the camera's white EF-S lens mount index and turn the lens as shown by the arrow until it clicks in place.
- When attaching a lens other than an EF-S lens, align the lens with the red EF lens mount index.

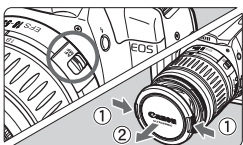

3 On the lens, set the focus mode switch to <AF> (autofocus).

- If it is set to <MF> (manual focus), autofocus will not operate.

4 Remove the front lens cap.

Detaching the Lens

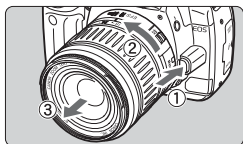

While pressing the lens release button, turn the lens as shown by the arrow.

- Turn the lens until it stops, then detach it.

⚠ When attaching or detaching the lens, take care to prevent dust from entering the camera through the lens mount.

How to Shoot

Power Switch

The camera can operate only after the power switch is turned on.

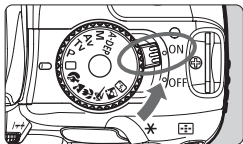

<ON> : The power lamp lights, and the camera turns on.

<OFF>: The camera is off and does not operate. Set to this position when not using the camera.



- When the power switch is turned on or off, the  icon is displayed on the LCD monitor to indicate that self-cleaning sensor system is operating.
- To save battery power, the camera turns off automatically after about 30 seconds of non-operation. To turn on the camera again, just press the shutter button.
- You can change the auto power-off time with the menu's [**f11 Auto power off**] setting. (p.95)
- If you set the power switch to <OFF> while the image is being recorded to the CF card, [**Recording ...**] will be displayed and the power will turn off after the CF card finishes recording the image.

Adjusting the Viewfinder Image

By adjusting the viewfinder to suit your eyesight, you can see a sharp viewfinder image even without eyeglasses.



Turn the dioptic adjustment knob.

- Turn the knob left or right so that the nine AF points in the viewfinder look sharp.



If the camera's dioptic adjustment still cannot provide a sharp viewfinder image, using Dioptic Adjustment Lens E (10 types, optional) is recommended.

Holding the Camera

To obtain sharp images, hold the camera still to minimize camera shake.

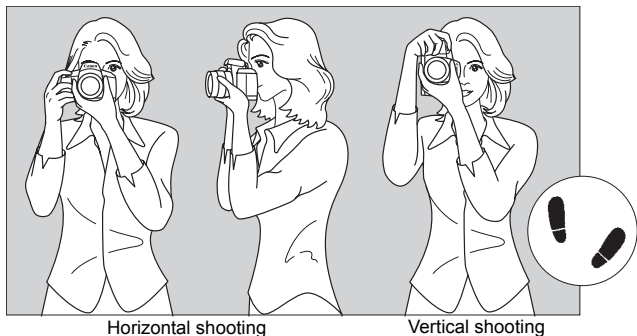

Holding the Camera

1. Hold the camera grip with your right hand.
2. Hold the bottom of the lens barrel with your left hand.
3. Press the shutter button lightly with your index finger on your right hand.

Steadying the Camera

4. Press your arms and elbows toward the front of your body.
5. Put your eye over the viewfinder as close as possible (the LCD monitor turns off).
6. Put one foot slightly forward to further steady your body.

* The LCD monitor cannot be used as a viewfinder for shooting.

Shutter Button

The shutter button has two steps. You can press the shutter button halfway. Then you can further press the shutter button completely.

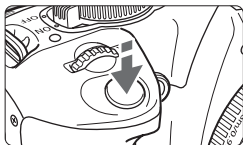

Pressing halfway

This activates autofocus (AF) and automatic exposure (AE) that sets the shutter speed and aperture.

The exposure setting (shutter speed and aperture) is displayed in the viewfinder.

(4)

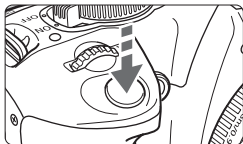

Pressing completely

This releases the shutter and takes the picture.

Preventing Camera Shake

Camera movement during the moment of exposure is called camera shake. Camera shake can cause blurred pictures. To prevent camera shake, note the following:

- Hold and steady the camera as shown on the previous page.
- Press the shutter button halfway to autofocus, then press the shutter button completely.



- If you press the shutter button completely without pressing it halfway first or if you press the shutter button halfway and then press it completely immediately, the camera will take a moment before it takes the picture.
- No matter what state the camera is in (image playback, menu operation, image recording, etc.), you can return to shooting instantly just by pressing the shutter button halfway (except during direct printing and while the direct image transfer screen is displayed).

Switching the LCD Monitor Screen

The LCD monitor can display the camera settings screen, menu screen, image, etc.

Camera Settings

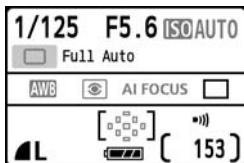

- Displayed when the camera is turned on.
- When your eye goes to the viewfinder eyepiece, the display-off sensor turns off the LCD monitor automatically. This prevents the bright LCD monitor from interfering with your view. The LCD monitor turns on again when your eye leaves the viewfinder eyepiece.
- While the menu screen or image is displayed as shown below, you can instantly return to the camera settings screen (shown on the left) by pressing the shutter button halfway.
- Pressing the <DISP.> button turns the display on or off.

- If you look at the viewfinder while wearing sunglasses, the LCD monitor might not turn off automatically. In such a case, press the <DISP.> button to turn off the monitor.
- If a fluorescent light is nearby, the LCD monitor might turn off. If this happens, take the camera away from the fluorescent light.

Menu Screen

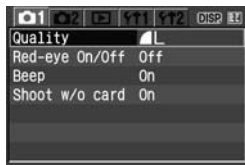

- Appears when you press the <MENU> button. Press the button again to display the camera settings.

Captured Image



- Displays when you press the <▶> button. Press the button again to display the camera settings.

Menu Operations and Settings

By setting various optional settings with the menus, you can set the image recording quality, the date/time, LCD monitor brightness, etc. While looking at the LCD monitor, you use the <MENU> button, <◀▶> cross keys, and <SET> button on the camera back.

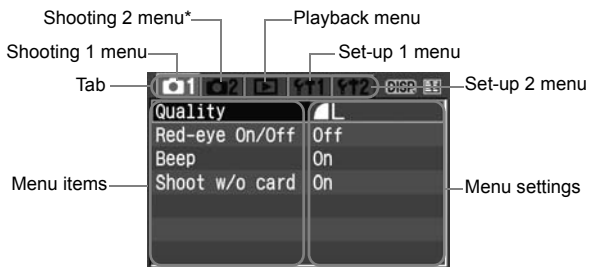
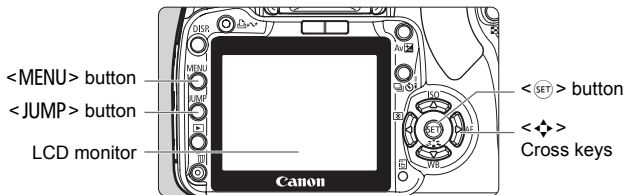

* The [CAMERA] tab is not displayed in Basic Zone shooting modes such as Full Auto.

Icon	Color	Category	Description
	Red	Shooting menu	Shooting-related menu
	Blue	Playback menu	Image playback-related menu
	Yellow	Set-up menu	Camera's basic function settings



- To change the menu tab, press the <JUMP> button.
- When a Basic Zone mode is set, there are menu items which will not be displayed.
- You can also use the <◀▶> dial to select menu items or playback images.
- A list of menu functions is on page 156.

Menu Setting Procedure

1 Display the menu.

- Press the <MENU> button to display the menu.

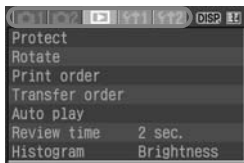

2 Select a tab.

- Press the <JUMP> button to select a menu tab.
- If the tabs are highlighted, you can also press the <◀▶> key to select a tab.



3 Select a menu item.

- Press the <▲▼> key to select the menu item, then press <SET>.



4 Select the menu setting.

- Press the <▲▼> or <◀▶> key to select the setting. (Some settings require you to press either the <▲▼> or <◀▶> key to select it.)



5 Set the desired setting.

- Press <SET> to set it.

6 Exit the menu.

- Press the <MENU> button to return to the camera setting display.

 The explanation of menu functions hereinafter assumes that you have pressed the <MENU> button to display the menu screen.

Before You Start

MENU Choose the Interface Language

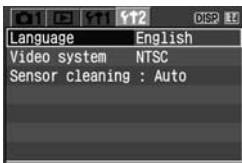

1 Select [Language].

- Under the [**Y/T2**] tab, select [**Language**], then press < **SET** >.
- ▶ The Language screen will appear.



2 Set the desired language.

- Press the < **◀▶** > key to select the desired language, then press < **SET** >.
- ▶ The language will change.

MENU Setting the Date and Time

Check if the camera's date and time are set correctly. If necessary, set the correct date and time.

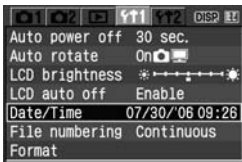

1 Select [Date/Time].

- Under the [**Y/T1**] tab, select [**Date/Time**], then press < **SET** >.
- ▶ The Date/Time screen will appear.



2 Set the date and time.

- Press the < **◀▶** > key to select the date or time number.
- Press the < **▲▼** > key to select the correct numeral.
- Press < **SET** > to confirm the date/time and return to the menu.



It is important to set the correct date/time because it will be recorded together with each captured image.

MENU Formatting the CF Card

For a new CF card or a CF card previously formatted by another camera or personal computer, format the card with this camera.

- !** **Formatting a CF card will erase everything in the card. Even protected images will be erased, so make sure there is nothing you need to keep. If necessary, transfer the recorded data to a personal computer before formatting the card.**

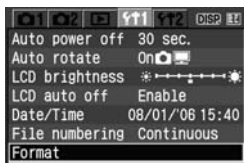

1 Select [Format].

- Under the [Y1] tab, select [Format], then press <SET>.
- ▶ The confirmation dialog will appear.

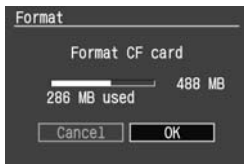

2 Format the CF card.

- Select [OK], then press <SET>.
- ▶ The CF card will be formatted (initialized).
- ▶ When the formatting is completed, the menu will reappear.

- !**
- When the card is formatted, only the file management information is changed. The actual data is not completely erased. Keep this in mind when giving the memory card to another person or discarding it.
 - When discarding the card, destroy the card physically to prevent the data from being stolen.
 - If a CF card-related error message is displayed on the LCD monitor, there is a problem with the CF card. Remove and reinstall the CF card. If the error persists, use a different CF card. Or, if you can transfer all the images in the CF card to a personal computer, transfer all the images and then format the card. The card may then return to normal.

 The CF card's capacity displayed on the card format screen may be lower than the capacity indicated on the card.

2

Basic Shooting and Image Playback

This chapter explains how to use the Basic Zone modes on the Mode Dial for best results and how to playback images.

With the Basic Zone modes, all you do is point and shoot and the camera sets everything automatically. Also, to prevent botched pictures due to mistaken operations, camera settings cannot be changed in the Basic Zone modes. The settings (functions set automatically) which cannot be set by the user are grayed out.

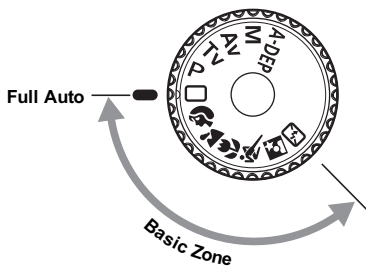

☐ Fully Automatic Shooting

1 Set the Mode Dial to <☐>.

AF point

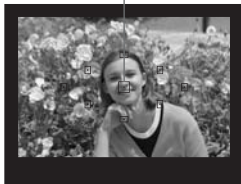

2 Aim any AF point over the subject.

- All the AF points will operate, and focus will generally be achieved at the AF point covering the closest object.
- Aiming the center AF point over the subject will make focusing easier.

3 Focus the subject.

- Press the shutter button halfway, and the lens will move to focus.
- ▶ The dot inside the AF point achieving focus flashes briefly in red. At the same time, the beeper will sound and the focus confirmation light <●> in the viewfinder will light.
- ▶ If necessary, the built-in flash will pop-up automatically.

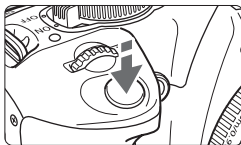

Focus confirmation light

4 Take the picture.

- Press the shutter button completely to take the picture.
- ▶ The captured image will be displayed for about 2 sec. on the LCD monitor.
- If the built-in flash has popped up, push it back down with your fingers.

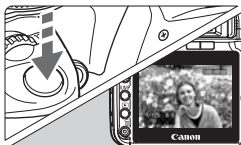

FAQ

- **The focus confirmation light <●> blinks and focus is not achieved.**
Aim the AF point over a part having good contrast between light and dark, then press the shutter button halfway. (p.160) If you are too close to the subject, move away and try again.
- **Sometimes multiple AF points flash simultaneously.**
This indicates that focus has been achieved at all those AF points. As long as the AF point covering the desired subject flashes, you can take the picture.
- **The beeper continues to beep softly. (The focus confirmation light <●> also does not light.)**
It indicates that the camera is focusing continuously on a moving subject. (The focus confirmation light <●> does not light.) While the beeper is beeping, you can press the shutter button completely to shoot a moving subject in focus.
- **Pressing the shutter button halfway will not focus the subject.**
When the focus mode switch on the lens is set to <MF> (Manual Focus), the camera does not focus. Set the focus mode switch to <AF>.
- **When I focus the subject and then zoom up and take the picture, the focus looks soft.**
If you want to zoom, do it before focusing. Turning the zoom ring after achieving focus may throw off the focus slightly.
- **Although it is daylight, the flash popped up.**
For a backlit subject, the flash may pop up to help reduce harsh shadows on the subject.
- **In low light, the built-in flash fired a series of flashes.**
To assist the autofocusing, pressing the shutter button halfway may trigger the built-in flash to fire a series of flashes. This is called AF-assist beam. It is effective up to approx. 4 meters/13.1 feet away.
- **Although flash was used, the picture came out dark.**
The subject was too far away. The subject should be within 5 meters/16.4 feet from the camera.
- **When flash was used, the bottom part of the picture came out unnaturally dark.**
The subject was too close to the camera, and a shadow was created by the lens. The subject should be at least 1 meter/3.3 feet away from the camera. If a hood (optional) has been attached to the lens, remove it before taking the flash picture.

□ Full Auto Techniques

Recomposing the Shot



Depending on the scene, position the subject toward the left or right to create a balanced background and good perspective.



In the <□> (Full Auto) mode, while you press the shutter button halfway to focus a still subject, the focus will be locked. You can then recompose the shot and press the shutter button completely to take the picture. This is called focus lock. Focus lock is also possible in other Basic Zone modes (except <📷>).

Shooting a Moving Subject



In the <□> (Full Auto) mode, if the subject moves (distance to camera changes) during or after you focus, the AI Servo AF will take effect to focus the subject continuously. As long as you keep aiming the AF point on the subject while pressing the shutter button halfway, the focusing will be continuous. When you want to take the picture, press the shutter button completely.

Shooting Portraits

The <> (Portrait) mode blurs the background to make the human subject stand out. It also makes flesh tones and the hair look softer than with the <> (Full Auto) mode.



Shooting Tips

- **The further the distance between the subject and background, the better.**



The further the distance between the subject and background, the more blurred the background will look. The subject will also stand out better in front of a plain, dark background.

- **Use a telephoto lens.**
If you have a zoom lens, use the telephoto end to fill the frame with the subject from the waist up. Move in closer if necessary.
- **Focus the face.**
Check that the AF point covering the face flashes in red.



- If you hold down the shutter button, you can shoot continuously to obtain different poses and facial expressions. (Approx. 3 shots/sec.)
- If necessary, the built-in flash will pop-up automatically.

Shooting Landscapes

Use the <  > (Landscape) mode for wide scenery, night scenes, and to have everything in focus from near to far. The greens and blues also become more vivid and sharp than with <  > (Full Auto).



Shooting Tips

- **Use a wide-angle lens.**

When using a zoom lens, use the wide-angle end. This will have objects near and far in focus, better than at the telephoto end. It also adds breadth to landscapes.

- **Shooting night scenes.**

Since the built-in flash will be disabled, this mode is also good for night scenes. For night scenes, use a tripod to prevent camera shake. If you want to photograph a person against a night scene, set the Mode Dial to <  > and use a tripod. (p.47)





Shooting Close-ups

When you want to photograph flowers or small things up close, use the <> (Close-up) mode. To make small things appear much larger, use a macro lens (optional).



Shooting Tips

- **Use a simple background.**
A simple background makes the flower, etc., stand out better.
- **Move to the subject as close as possible.**
Check the lens for its minimum focusing distance. Some lenses have indications such as < **0.28m/0.9ft**>. The lens minimum focusing distance is measured from the <> (focal plane) mark on the camera to the subject. If you are too close to the subject, the focus confirmation light <> will blink.
Under low light, the built-in flash will fire. If you are too close to the subject and the bottom of the picture looks dark (due to the lens barrel obstructing the flash), move away from the subject.
- **With a zoom lens, use the telephoto end.**
If you have a zoom lens, using the telephoto end will make the subject look larger.

Shooting Moving Subjects

To photograph a moving subject whether it be a child running or an auto race, use the  (Sports) mode.



Shooting Tips

- **Use a telephoto lens.**

Using a telephoto lens is recommended so you can shoot from afar.

- **Use the center AF point to focus.**

Aim the center AF point over the subject, then press the shutter button halfway to auto focus. During autofocusing, the beeper will continue beeping softly. If focus cannot be achieved, the focus confirmation light  will blink.

When you want to take the picture, press the shutter button completely. While holding down the shutter button, continuous shooting (max. approx. 3 shots per sec.) and autofocusing will take effect.



 Under low light when camera shake is prone to occur, the viewfinder's shutter speed display on the lower left will blink. Hold the camera steady and shoot.

Shooting Portraits at Night

To shoot someone at night and obtain a natural-looking exposure in the background, use the  (Night Portrait) mode.



Shooting Tips

- **Use a wide-angle lens and a tripod.**
If you use a zoom lens, set it to the wide-angle end to obtain a wide night view. For night scenes, use a tripod to prevent camera shake.
- **Keep the person within 5 meters/16.4 feet from the camera.**
Under low light, the built-in flash will fire automatically to obtain a good exposure of the person. The effective distance of the built-in flash is 5 meters/16.4 feet from the camera.
- **Shoot also with  (Full Auto).**
Since camera shake is prone to occur with night shots, shooting also with  (Full Auto) is recommended.



If the self-timer is also used, the self-timer lamp will flash after the picture is taken.

Disabling Flash

In places where flash photography is prohibited, use the <> (Flash Off) mode. This mode is also effective for candlelight scenes when you want to obtain the candlelight effect.



Shooting Tips

- **If the numeric display in the viewfinder blinks, take care to prevent camera shake.**

Under low light when camera shake is prone to occur, the viewfinder's shutter speed display will blink. Hold the camera steady or use a tripod. If you have a zoom lens, use the wide-angle end to reduce blur due to camera shake.

- **Taking portraits without flash.**

Under low light, the person must not move until the picture is taken. If the person moves during the exposure, he or she might look blurred in the picture.

🕒 Using the Self-timer

Use the self-timer when you want to be in the picture. The self-timer can be used in any shooting mode.

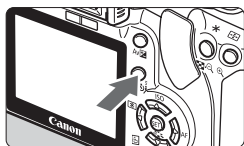

1 Press the button.

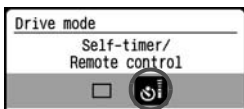

2 Select .

- Press the key to select .

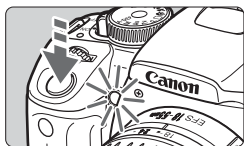

3 Take the picture.

- Focus the subject and press the shutter button completely.
- ▶ The beeper will sound, the self-timer lamp will blink, and the shot will be taken about 10 sec. later. Two seconds before the picture is taken, the beeping will be faster and the self-timer lamp will stay on.
- ▶ During the self-timer operation, the LCD monitor counts down the seconds until the picture is taken.

Cancelling the self-timer

Press the button and press the key to select a mode other than .



Do not stand in front of the camera when you press the shutter button to start the self-timer. Doing so will throw off the focus.



- Use a tripod when you use the self-timer.
- When using the self-timer to shoot only yourself, use focus lock (p.42) for an object at about the same distance as where you will be.
- To cancel the self-timer after it starts, press the button.

▶ Image Playback

The easiest way to playback images is explained below. For more details on image playback methods, see page 115.



1 Playback the image.

- When you press the <▶> button, the last captured image will be displayed.

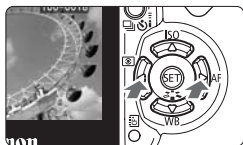

2 Select the image.

- To view images starting with the last image, press the <◀> key. To view images starting with the first (oldest) image, press the <▶> key.
- Press the <DISP.> button to switch the display format.

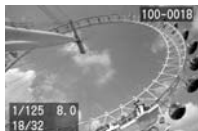

Single image display
(with basic info)

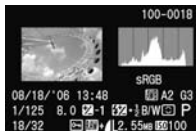

Shooting information
display



Single image display
(no shooting info)

* For more details on shooting information, see pages 124, 125.

3 Exit the image playback.

- Press the <▶> button to return to the camera setting display.

3

Advanced Shooting Techniques

In the Basic Zone modes, most functions are set automatically and cannot be changed to prevent spoiled shots. In the <P> (Program AE) mode, you can set various functions and be more creative.

- In the <P> (Program AE) mode, the camera sets the shutter speed and aperture automatically to obtain the standard exposure.
- The difference between the Basic Zone modes and <P> is explained on page 158.

* <P> stands for Program.

* AE stands for Auto Exposure.

P: Program AE

To obtain a good exposure of the subject, the camera sets the exposure (shutter speed and aperture) automatically. This is called Program AE.



1 Set the Mode Dial to <P>.

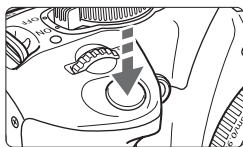

2 Take the picture.

- Focus the subject and press the shutter button completely.
- ▶ The captured image will be displayed for about 2 sec. on the LCD monitor.



Shooting Tips

● Check the shutter speed in the viewfinder.

When you press the shutter button halfway, the bottom of the viewfinder will display the shutter speed from 30" to 4000 (30 - 1/4000 sec.). The darker it is, the lower the number (slower shutter speed) will be. A slower shutter speed is more likely to result in camera shake.

As a general rule, if the shutter speed is slower (lower number) than the reciprocal of the lens focal length multiplied by 1.6 (For example, if the lens focal length is 55mm, 55×1.6 is 80 so the reciprocal of 1/80) is the minimum shutter speed required to prevent camera shake. If the shutter speed is slower than this, either increase the ISO speed (p.53) or use the flash (p.54).

● The program can be shifted. (Program shift)

After pressing the shutter button halfway, turn the <⚙> dial to change the shutter speed and aperture setting combination (program).

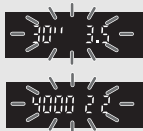

In very low light or very bright light, the exposure setting will blink when you press the shutter button halfway, as shown in the figure. In low light, either increase the ISO speed (p.53) or use flash (p.54). In bright light, decrease the ISO speed.

ISO: Changing the ISO Speed ★

Set the ISO speed (imaging sensor's sensitivity to light) to suit the ambient light level. For example, when you increase the ISO speed (higher number) for low light, a faster shutter speed can be used and camera shake will be less prone to occur. The effective range of the flash will also increase.

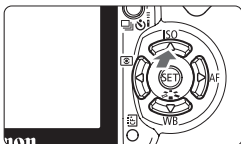

- 1 Press the <▲ ISO> button.**
 - ▶ [ISO speed] will appear.

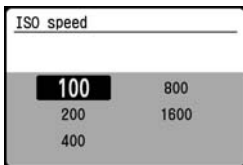

- 2 Select the ISO speed.**
 - Press the <◆> key to select the desired ISO speed, then press the shutter button halfway.

ISO Speed Guide

ISO Speed	Normal (No flash)	Flash Range
100/200	Sunny outdoors	See page 54
400/800	Overcast skies, evening	
1600	Night or dark indoors	

- Using a high ISO speed or shooting in high-temperature conditions may result in slightly grainy images.
- High temperatures, high ISO speeds, or long exposures may cause irregular colors in the image.

- In the Basic Zone modes, the ISO speed will be set automatically within ISO 100 - 400 to match the respective light level.
- With ISO 800 or 1600, camera shake is less prone to occur than with the Basic Zone modes. The flash range will also be longer.

Using the Built-in Flash

In indoors, low light, or backlit conditions, just pop-up the built-in flash and press the shutter button to take flash pictures. In the <P> mode, the shutter speed (1/60 sec. - 1/200 sec.) will be set automatically to prevent camera shake.

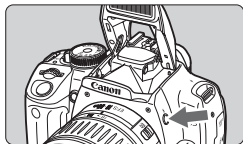

1 Press the <⚡> button.

- In Creative Zone modes, you can press the <⚡> button anytime to take flash pictures.
- While the flash is recycling, “⚡buSY” is displayed in the viewfinder, and [BUSY⚡] is displayed on the upper left of the LCD monitor.

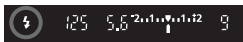

2 Press the shutter button halfway.

- In the bottom left of the viewfinder, check that the <⚡> icon is lit.

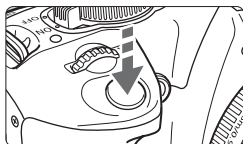

3 Take the picture.

- When focus is achieved and you press the shutter button completely, the flash will fire for the picture.

Effective Flash Range

[Approx. in meters / feet]

ISO speed	EF-S18-55mm f/3.5-5.6 II		EF-S17-85mm f/4-5.6 IS USM	
	Wide angle: 18mm	Telephoto: 55mm	Wide angle: 17mm	Telephoto: 85mm
100	1 - 3.7 / 3.3 - 12.1	1 - 2.3 / 3.3 - 7.5	1 - 3.3 / 3.3 - 10.8	1 - 2.3 / 3.3 - 7.5
200	1 - 5.3 / 3.3 - 17.4	1 - 3.3 / 3.3 - 10.8	1 - 4.6 / 3.3 - 15.1	1 - 3.3 / 3.3 - 10.8
400	1 - 7.4 / 3.3 - 24.3	1 - 4.6 / 3.3 - 15.1	1 - 6.5 / 3.3 - 21.3	1 - 4.6 / 3.3 - 15.1
800	1 - 10.5 / 3.3 - 34.4	1 - 6.6 / 3.3 - 21.7	1 - 9.2 / 3.3 - 30.2	1 - 6.6 / 3.3 - 21.7
1600	1 - 14.9 / 3.3 - 48.9	1 - 9.3 / 3.3 - 30.5	1 - 13.0 / 3.3 - 42.7	1 - 9.3 / 3.3 - 30.5



⚠ If you shoot 20 images with flash at short intervals, the flash might stop operating. This is to protect the flash unit. If you press the shutter button halfway and “⚡buSY” is displayed in the viewfinder (and [BUSY⚡] on the LCD monitor), wait until the display turns off. You can then use flash again.





Shooting Tips

- **If the subject is far away, increase the ISO speed.**
A higher ISO speed increases the effective range or distance of the flash.
- **In bright light, decrease the ISO speed.**
If the exposure setting in the viewfinder blinks in bright light, decrease the ISO speed.
- **Detach the lens hood and keep at least 1 meter/3.3 feet away from the subject.**
If the lens hood (optional) is attached or if you are too close to the subject, the bottom portion of the picture might turn out dark. For important shots, check the image on the LCD monitor to make sure the flash exposure looks good (not dark at the bottom).
- **Shooting without the built-in flash.**
Shooting under low light can cause blur due to camera shake. Hold the camera as still as possible or use a tripod.

Using Red-eye Reduction

Using the red-eye reduction lamp before taking a flash picture can reduce red eye. Red-eye reduction can be set in any shooting mode except <  > <  > <  >.



- Under the [] tab, select [**Red-eye On/Off**] and press <  >. Set it to [**On**], then press <  >.
- When you press the shutter button halfway, the red-eye reduction lamp will light. Then when you press the shutter button completely, the picture will be taken.



- The red-eye reduction feature is most effective when the subject looks at the red-eye reduction lamp, when the room is well lit, and when you go closer to the subject.
- When you press the shutter button halfway, the viewfinder display on the bottom right will gradually turn off. For best results, take the picture after this display turns off.
- The effectiveness of red-eye reduction varies from subject to subject.

AF: Changing the AF Mode★

You can change the AF mode to suit different subjects such as group photos, animals, and sports.

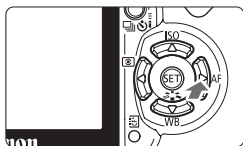

1 Press the <▶AF> button.

- ▶ [AF mode] will appear.

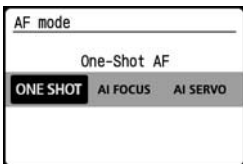

2 Select the AF mode.

- Press the <◀▶> key to select the AF mode.

3 Focus the subject.

- Aim the AF point over the subject and press the shutter button halfway. The camera will then autofocus in the selected AF mode.

Selecting the Best AF Mode

● One-Shot AF

Ideal for still subjects and snapshots. When you press the shutter button halfway, the camera will focus only once. While you hold down the shutter button halfway, the focus will be locked. You can then recompose the shot if desired.

● AI Focus AF

This is for subjects moving unpredictably, such as animals. When you press the shutter button halfway, the camera will focus in the same way as One-Shot AF. Then if the subject starts to move, the camera switches to AI Servo AF and focuses continuously.

* AI stands for Artificial Intelligence.

● AI Servo AF

Geared for sports photography and other moving subjects. While you hold down the shutter button halfway, the focus and exposure setting will be adjusted continuously.

Selecting the AF Point ★

In the Image Zone modes, all the AF points are active. Generally, the AF point covering the closest subject will be selected to focus.

Therefore, the camera sometimes may not focus the subject you want. With the <P> (Program AE), <Tv>, <Av>, and <M> modes, you can select one AF point to focus where you want.

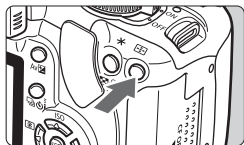

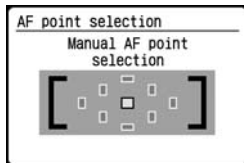

1 Press the button. (06)

- ▶ The selected AF point is indicated on the LCD monitor and in the viewfinder.
- When all AF points light up, automatic AF point selection will be set.



2 Select the AF point.

- Press the  key to select the AF point.
- While looking at the viewfinder, you can select the AF point by turning the  dial until the desired AF point flashes in red.
- Pressing  toggles the AF point selection between the center AF point and automatic AF point selection.

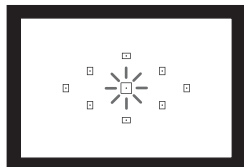

3 Focus the subject.

- Aim the selected AF point over the subject and press the shutter button halfway to focus.



Shooting Tips

- **When shooting a portrait up close, use One-Shot AF and focus the eyes.**

If you focus the eyes first, you can then recompose and the face will remain sharp.

- **If it is difficult to focus, select and use the center AF point.**

The center AF point focuses the best among the nine AF points. Also, with a fast lens from f/1.0 to f/2.8, high-precision focusing takes effect with the center AF point.

- **To make it easier to focus a moving subject, set the camera to automatic AF point selection and AI Servo AF.**

First use the center AF point to focus. If the subject moves away from the center AF point, the other AF points will continue to focus-track the subject automatically.

Manual Focusing

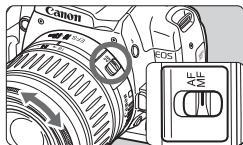

Focusing ring

- 1 **Set the lens focus mode switch to <MF>.**

- 2 **Focus the subject.**

- Focus by turning the lens focusing ring until the subject looks sharp in the viewfinder.





- If you press the shutter button halfway during manual focusing, the AF point achieving focus flashes briefly and the focus confirmation light <●> in the viewfinder will light.
- <AF> stands for Auto Focus. <MF> stands for Manual Focus.

Continuous Shooting ★

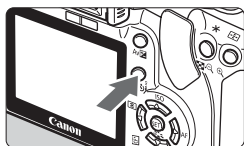

Up to about 3 shots per sec. can be taken. This is effective for shooting your child running toward you and capturing the different facial expressions.

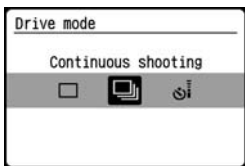

1 Press the   button.



2 Select  .

- Press the   key to select .

3 Take the picture.

- The camera shoots continuously while you hold down the shutter button fully.



Shooting Tips

- Also set the AF mode to match the subject.

Moving subject:

When AI Servo AF is set, focusing will be continuous during continuous shooting.

Still subjects:

When One-Shot AF is set, the camera will focus only once during continuous shooting.

- Flash can also be used.

Since the flash will require recharging time, the continuous shooting speed will be slower.

- If “buSY” is displayed in the viewfinder, wait a few seconds before resuming.

This indicates that the camera's buffer memory is full and shooting cannot continue. When you press the shutter button halfway and “buSY” is not displayed, you can start shooting again.



In the AI Servo AF mode, the continuous shooting speed may become slower depending on the subject and the lens used.

MENU Setting the Image-Recording Quality

Set the recording quality to suit the intended image size for printing, etc. Note that the recording quality will also affect the number of shots the CF card can record. Select the recording quality while thinking about the capacity of the CF card to be used. Also see “Guide to Image-recording Quality Settings” below and “FAQ” on the next page.

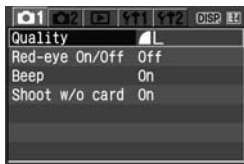

Select the image-recording quality.

- Under the [📷1] tab, select [Quality] and press <SET>. Set it to the desired recording quality such as [L], then press <SET>.
- [Quality] will be displayed.
- The figures (**** x ****) displayed on the upper right is the actual pixel count (horizontal x vertical) for the respective quality setting.

Guide to Image-recording Quality Settings



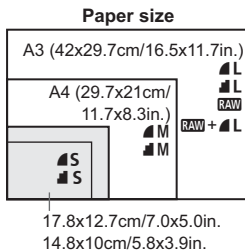











Quality		Pixels	Possible Shots
L	High quality	Approx. 10.1 million	128
			248
M	Medium quality	Approx. 5.3 million	215
			409
S	Low quality	Approx. 2.5 million	374
			708
RAW	High quality	Approx. 10.1 million	48
RAW + L			26



* Applies to a 512MB CF card.

* Except for the RAW mode, the JPEG is used to record the image in all the recording-quality modes.

FAQ

- **What's the difference between L, M, S, , and .**
L, **M**, and **S** indicate the image size. **L**: Large, **M**: Medium, and **S**: Small,  (Fine) and  (Normal) indicate the image quality based on the data compression rate. The  image has higher image quality. If  is selected, the image quality will be slightly lower, but more images can be saved to the CF card.
- **Which recording quality is recommended?**
 You have to take into consideration the capacity of the CF card, the size of the paper for printing the image, and the number of shots you plan to take. For example, if you use a 512MB CF card to take 100 shots, select the highest image quality  **L**. Or if you use a 256MB CF card to shoot 80 shots and want to print on A3-size or larger paper, select  **L**. If it will be A4 size, select  **M**.
- **Can the image-recording quality also be selected in the Basic Zone modes?**
 Yes, the image-recording quality other than **RAW** and **RAW** +  **L** can be selected. Set the recording quality in both the Basic Zone and Creative Zone modes respectively.
- **What is the shooting capacity with CF cards other than 512MB?**
 Format the CF card and check the number of possible shots on the LCD monitor.
- **I took more shots than the number of possible shots indicated.**
 Depending on the shooting conditions, you may be able to take more shots than was indicated. Or, you might be able to take fewer shots than indicated. The possible shots displayed is only an estimate.
- **How many shots can be taken continuously? (Maximum burst)**
 **L**: 27 shots, **RAW**: 10 shots, **RAW** +  **L**: 8 shots. In other image-recording quality modes, the maximum burst will be higher than  **L**. When the maximum burst is 8 or lower, the number normally indicated as "9" on the bottom right of the viewfinder will display a lower number. Note that this number will also be displayed even when no CF card is installed in the camera. Be careful not to shoot without a CF card in the camera.
- **How large is the file size of one image?**
 See "File size" on page 166.
- **When do I use the **RAW** mode?**
 RAW images require processing with your personal computer. For details, see "About **RAW**" and "About **RAW** +  **L**" on the next page.

About RAW

RAW is the raw data before it is made into a **L** and other images. Although RAW images require software like Digital Photo Professional (provided) so they can be displayed on the computer, they also offer flexibility for image adjustments possible only with RAW. RAW is effective when you want to create your own art or shoot an important subject.

For example, with a RAW image, you can use the software to change the Picture Styles (see next page) freely to create various versions of the same image: Landscape-type colors, monochrome, or even sepia toning. Also, if you took the picture with the wrong white balance (explained in Chapter 4), you can change the white balance without degrading the image quality.

Note that RAW images will not work with direct printing or DPOF.

About RAW + L

RAW + L records both a RAW image and JPEG image with a single shot. The two images are saved to the CF card. Since the **L** image is recorded as a processed image, you can view it as is on a personal computer without the bundled software or print it as is. With **RAW + L**, the two images are saved with the same file number in the same folder. You can distinguish between them with the image type or extension. The RAW image's extension is "CR2", and the **L** image's extension is "JPG".



MENU Selecting a Picture Style ★

By selecting a Picture Style, you can obtain the desired image effects matching your photographic expression or the subject.

Picture Style	
Standard	Monochrome
Portrait	User Def. 1
Landscape	User Def. 2
Neutral	User Def. 3
Faithful	

1 Select [Picture Style].

- Press <SET> and [Picture Style] will appear.
- Press the <▲▼> key to select the desired Picture Style.

2 Take the picture.

- Focus and press the shutter button completely. The picture will be taken with the selected Picture Style applied.

Picture Style Effects

● Standard

The image looks vivid, sharp, and crisp. This is a general-purpose Picture Style suitable for most scenes.

● Portrait

For nice skin tones. The image looks slightly sharp and crisp. Effective for close-ups of women or children. This Picture Style is also selected automatically when the Mode Dial is set to <P>. By changing the [Color tone] (p.79), you can adjust the skin tone.

● Landscape

For vivid blues and greens, and very sharp and crisp images. Effective for impressive landscapes. This Picture Style is also selected automatically when the Mode Dial is set to <L>.

● Neutral

This is for users who prefer to process images with their personal computer. For natural colors and subdued images.

- **Faithful**

This is for users who prefer to process images with their personal computer. When the subject is photographed under a color temperature of 5200K, the color is adjusted colorimetrically to match the subject's color. The image is dull and subdued.

- **Monochrome**

For black-and-white photos.

Other than with RAW, the black-and-white photo cannot be reverted to color. If you want to later shoot pictures in color, make sure the [Monochrome] setting has been canceled. When [Monochrome] is selected, <B/W> will appear on the LCD monitor.

- **User Def. 1-3**

You can register your own Picture Style settings (p.81) for **[Portrait]**, **[Landscape]**, etc. Any User Defined Picture Style which has not been set will have the same settings as the Standard Picture Style.

4

More Advanced Techniques

This chapter builds on the previous chapter and introduces more ways to shoot creatively.

- The first half of this chapter explains how to use the **<Tv>** **<Av>** **<M>** **<A-DEP>** modes on the Mode Dial. Except for **<A-DEP>**, all the shooting modes can be used in combination with the functions introduced in Chapter 3.
- The second half of this chapter, starting with “Changing the Metering Mode” explains the methods to adjust the exposure and the Picture Styles. All the functions introduced in this chapter can also be used with the **<P>** (Program AE) mode introduced in Chapter 3.

Tv: Action Shots

You can either freeze the action or create motion blur with the **<Tv>** (Shutter-priority AE) mode on the Mode Dial.

* **<Tv>** stands for Time value.



Frozen action



Blurred action



1 Set the Mode Dial to **<Tv>**.

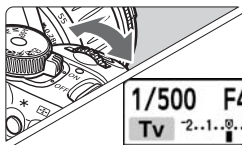

2 Set the desired shutter speed.

- See “Shooting Tips” for advice on setting the shutter speed.
- Turning the  dial to the right sets a faster shutter speed, and turning it to the left sets a slower one.



3 Take the picture.

- When you focus and press the shutter button completely, the picture will be taken at the selected shutter speed.



About the Shutter Speed Display

The LCD monitor displays the shutter speed as a fraction. However, the viewfinder displays only the denominator. Also, “0”5” indicates 0.5 sec. and “15” is 15 sec.



Shooting Tips

- **To freeze the action or moving subject.**
Use a fast shutter speed such as 1/500 sec. to 1/4000 sec.
- **To blur a running child or animal giving the impression of fast movement.**
Use a medium shutter speed such as 1/60 sec. to 1/250 sec. Follow the moving subject through the viewfinder and press the shutter button to take the picture. If you use a telephoto lens, hold it steady to prevent camera shake.
- **How to blur a flowing river or water fountain.**
Use a slow shutter speed such as 1/5 sec. to 1/15 sec. Use a tripod to prevent camera shake.
- **Set the shutter speed so that the aperture display does not blink in the viewfinder.**

If you press the shutter button halfway and change the shutter speed while the aperture is displayed, the aperture display will also change to maintain the same exposure (amount of light reaching the imaging sensor). If you exceed the adjustable aperture range, the aperture display will blink to indicate that the standard exposure cannot be obtained.

If the exposure will be too dark, the lowest aperture value will blink. If this happens, turn the  dial to the left to set a slower shutter speed or increase the ISO speed.

If the exposure will be too bright, the highest aperture value will blink. If this happens, turn the  dial to the right to set a faster shutter speed or decrease the ISO speed.

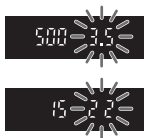

Using the Built-in Flash

The flash exposure will be set automatically to match the aperture that was set automatically. The flash sync speed can be set from 30 sec. to 1/200 sec.

Av: Changing the Depth of Field

To obtain a blurry background or to make everything near and far look sharp, set the Mode Dial to <Av> (Aperture-priority AE) to adjust the depth of field (range of acceptable focus).

* <Av> stands for Aperture value which is the size of the diaphragm hole inside the lens.



Blurred background



Sharp foreground and background

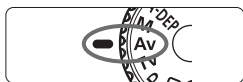

1 Set the Mode Dial to <Av>.

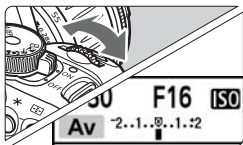

2 Set the desired aperture.

- The higher the aperture value, the sharper the picture will look with a wider depth of field.



3 Take the picture.

- Focus and press the shutter button completely. The picture will be taken with the selected aperture.



About the Aperture Display

The larger the f/number, the smaller the aperture opening will be. The apertures displayed will differ depending on the lens. If no lens is attached to the camera, "00" will be displayed for the aperture.



Shooting Tips

- **When using a high aperture value, note that camera shake can occur in low light scenes.**

A higher aperture value will make the shutter speed slower. Under low light, the shutter speed can be as long as 30 sec. In such cases, increase the ISO speed and hold the camera steady or use a tripod.

- **The depth of field depends not only on the aperture, but also the lens and subject distance.**

Since wide-angle lenses have a wide depth of field, you need not set a high aperture value to obtain a sharp picture from the foreground to the background. On the other hand, a telephoto lens has a narrow depth of field.

And the closer the subject, the narrower the depth of field. A farther subject will have a wider depth of field.

- **Set the aperture so that the shutter speed display does not blink in the viewfinder.**

If you press the shutter button halfway and change the aperture while the shutter speed is displayed, the shutter speed display will also change to maintain the same exposure (amount of light reaching the imaging sensor). If you exceed the adjustable shutter speed range, the shutter speed display will blink to indicate that the standard exposure cannot be obtained.

If the picture will be too dark, the 30" (30 sec.) shutter speed display will blink. If this happens, turn the <  > dial to the left to set a lower aperture value or increase the ISO speed.

If the picture will be too bright, the 4000 (1/4000 sec.) shutter speed display will blink. If this happens, turn the <  > dial to the right to set a higher aperture value or decrease the ISO speed.



Using the Built-in Flash

The flash exposure will be set automatically to match the aperture that was set. The shutter speed will set automatically between 30 sec. - 1/200 sec. to suit the scene's brightness.

In low light, the main subject is exposed with the automatic flash, and the background is exposed with a slow shutter speed set automatically. Both the subject and background look properly exposed (automatic slow-speed flash sync). If you are handholding the camera, keep it steady to prevent camera shake. Using a tripod is recommended.

To prevent slow-speed sync, access the [F/T2 Custom Function (C.Fn)] menu's [Flash sync. speed in Av mode] (p.104) and set it to [1/200sec. (fixed)].

Depth-of-Field Preview ★

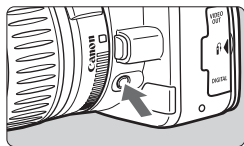

Press the depth-of-field preview button to stop down to the current aperture setting. You can check the depth of field (range of acceptable focus) through the viewfinder.

When you want to see the effect of the current depth of field, select the lowest aperture value and while holding down the depth-of-field preview button, look at the viewfinder. Then turn the  dial to the right to set a higher aperture value and see how the depth of field changes.

M: Manual Exposure



You can set both the shutter speed and aperture as desired. With flash, the flash exposure will be set automatically to match the aperture that was set. The flash sync speed can be set at bulb, or from 30 sec. to 1/200 sec.

* <M> stands for Manual.



1 Set the Mode Dial to <M>.

2 Set the shutter speed and aperture.

- To set the shutter speed, turn the <  > dial.
- To set the aperture, hold down the <Av > button and turn the <  > dial.

Standard exposure index





Exposure level mark

3 Set the exposure and take the picture.

- Press the shutter button halfway to focus.
- The exposure level indicator in the viewfinder indicates the exposure level up to ± 2 stops from the standard exposure index at the center. While you change the shutter speed and aperture, the exposure level mark will move. You can decide which exposure level to set.

Bulb Exposures

In step 2, turn the <  > dial left to set <BULB>. A bulb exposure keeps the shutter open for as long as you hold down the shutter button. It can be used to photograph fireworks, etc. If you press the <DISP.> button during the bulb exposure, the elapsed exposure time will be displayed.

 Since bulb exposures produce more noise than usual, the image will look rough or grainy. You can reduce this noise by setting the [f12 Custom Functions (C.Fn)] menu's [Long exp. noise reduction] (p.103) to [Auto] or [On].

A-DEP: Automatic Depth-of-Field AE

Objects in the foreground and background will be in focus automatically. All the AF points will function to detect the subject, and the aperture required to attain the necessary depth of field will be set automatically.

* <A-DEP> stands for Auto-Depth of field. This mode sets the depth of field automatically.



1 Set the Mode Dial to <A-DEP>.



2 Focus the subject.

- Aim the AF points over the subjects and press the shutter button halfway. (ⓘ4)
- All the subjects covered by the AF points flashing in red will be in focus.

3 Take the picture.

? FAQ

● The shutter speed display in the viewfinder blinks.

If the "30" shutter speed blinks, it means that the subject is too dark. Increase the ISO speed. If the "4000" shutter speed blinks, it means that the subject is too bright. Decrease the ISO speed.

● The aperture display in the viewfinder blinks.

The exposure is correct, but the desired depth of field cannot be obtained. Either use a wide-angle lens or move further away from the subjects.

● A slow shutter speed has been set.

Use a tripod.

● I want to use flash.

Flash can be used, however, the result will be the same as using the <P> mode with flash. The desired depth of field will not be obtained.

Changing the Metering Mode ★

The metering mode is the method of measuring the brightness of the subject. In the Basic Zone modes, evaluative metering is set. This need not be changed unless you really want to.

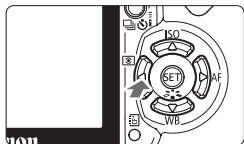

- 1 Press the <◀▶> button.**
 - ▶ [Metering mode] will appear.

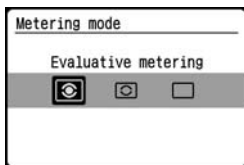

- 2 Select the metering mode.**
 - Press the <◀▶> key to select the desired metering mode.
 - When you press the shutter button halfway, the selected metering mode will be displayed on the LCD monitor.

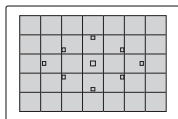

Evaluative metering

This is an all-around metering mode suited for portraits and even backlit subjects. The camera sets the exposure automatically to suit the scene.

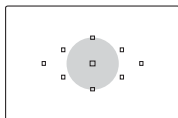

Partial metering

This is effective for backlit subjects when the light surrounding the subject is strong. The gray area in the left figure is where the metering is weighted to obtain the standard exposure.

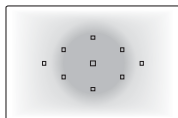

Center-weighted average metering

This is for advanced users for obtaining the correct exposure for backlit subjects and other scenes using appropriate exposure compensation.

Setting Exposure Compensation ★

When you photograph a white or black subject (such as clothing), the white might turn out darker and the black might look lighter. To obtain the desired color shade, set the exposure compensation and take the picture again. You can also set the exposure compensation to create bright or dark images as desired. This feature can be used in the Creative Zone modes (except <M>). The exposure compensation setting will not be automatically canceled when you turn off the camera. After taking the picture, reset the exposure compensation to zero.

Setting exposure compensation

Set exposure compensation if the exposure (without flash) does not come out as desired.

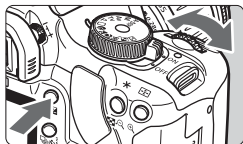

Making it brighter

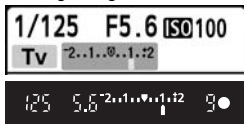

Making it darker

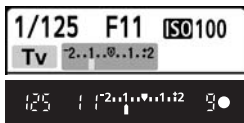

- **Making it brighter**

Hold down the <Av☒> button and turn the <☀> dial to the right.

- **Making it darker**

Hold down the <Av☒> button and turn the <☀> dial to the left.

▶ As shown in the figure, the exposure level is displayed on the LCD monitor and in the viewfinder.

- After taking the picture, hold down the <Av☒> button and turn the <☀> dial to reset the exposure compensation to zero.



Exposure is dark



Exposure compensation made it brighter

Flash Exposure Compensation ★



Set flash exposure compensation if the flash exposure of the main subject does not come out as desired. This feature also works with external EX-series Speedlites.

1 Select [Flash exp comp].

- Under the [2] tab, select [Flash exp comp], then press <SET>.



2 Set the flash exposure compensation amount.

- To make the flash exposure brighter, press the <▶> key. Or to make it darker, press the <◀> key.
- After setting the flash exposure compensation amount, press <SET>.
- When you press the shutter button halfway, the <> icon and flash exposure compensation amount will be displayed on the LCD monitor and the <> icon will appear in the viewfinder.
- After taking the picture, do step 2 to reset the flash exposure compensation amount to zero.

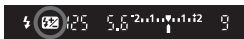



A bright flash exposure



Flash exposure compensation making it darker



When you set flash exposure compensation with an external Speedlite, the <> icon on the LCD monitor will change to <>. The flash exposure compensation amount will not be displayed.

MENU Auto Exposure Bracketing ★

This feature takes exposure compensation a step further by varying the exposure automatically with three shots as shown below. You can then choose the best exposure. This is called AEB (Auto Exposure Bracketing).



Standard exposure



Making it darker
(Decreased exposure)



Making it brighter
(Increased exposure)

1 Select [AEB].

- Under the [CAMERA] tab, select [AEB], then press <SET>.

2 Set the AEB amount.

- Press the <◀▶> key to set the AEB amount, then press <SET>.
- When you press the shutter button halfway, the <CAMERA> icon and AEB amount will be displayed on the LCD monitor.

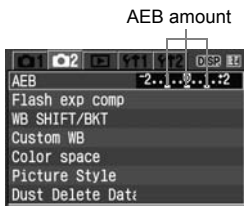

3 Take the picture.

- Focus and press the shutter button completely. The three bracketed shots will be taken in this sequence: Standard, decreased, and increased exposure.



Canceling AEB



- Follow steps 1 and 2 to set the AEB amount to $\langle -2.1..0..1.2 \rangle$.
- AEB will also be canceled automatically if you set the power switch to $\langle \text{OFF} \rangle$, change lenses, obtain flash-ready, replace the battery, or replace the CF card.



Shooting Tips

- **Using AEB with continuous shooting.**
If $\langle \text{C} \rangle$ (p.59) has been set and you press the shutter button completely, the three bracketed shots will be taken continuously in this sequence: Standard, decreased, and increased exposure.
- **Using AEB with $\langle \text{C} \rangle$ single shooting.**
Press the shutter button three times to take the three bracketed shots. The three bracketed shots will be exposed in the following sequence: Standard, decreased, and increased exposure.
- **Using AEB with exposure compensation.**
Based on the exposure compensation amount, the shots can be bracketed with decreased and increased exposures.
- **Using AEB with the self-timer or remote control.**
With the self-timer or remote control, the three bracketed shots will be taken continuously.
- **AEB cannot be used with flash.**
Neither flash nor bulb exposures can be used with AEB.

MENU Customizing the Picture Style ★

You can customize the Picture Style by changing the individual parameters like [Sharpness] and [Contrast]. To see the resulting effects, take test shots. To customize [Monochrome], see page 80.

1 Select [Picture Style].

- Under the [CAM2] tab, select [Picture Style], then press <SET>.
- ▶ The Picture Style selection screen will appear.

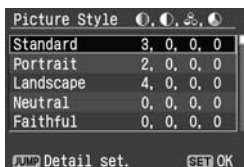

2 Select the Picture Style.

- Select the Picture Style, then press the <JUMP> button.
- ▶ The Detail set. screen will appear.



3 Select the parameter.

- Press the <▲▼> key to select the parameter such as [Sharpness], then press <SET>.



4 Adjust the parameter.

- Press the <◀▶> key to adjust the parameter as desired, then press <SET>.
- Press the <MENU> button to save the adjusted parameter. The Picture Style selection screen will reappear.
- ▶ Any settings different from the default will be displayed in blue.

Parameters Settings and Effects

Sharpness

Adjusts the sharpness of the image.

To make it less sharp, set it toward the **0** end. The closer it is to **0**, the softer the image will look.

To make it sharper, set it toward the **7** end. The closer it is to **7**, the sharper the image will look.

Contrast

Adjusts the image contrast and the vividness of colors.

To decrease the contrast, set it toward the minus end. The closer it is to **-**, the blander the image will look.

To increase the contrast, set it toward the plus end. The closer it is to **+**, the crisper the image will look.

Saturation

The image's color saturation can be adjusted.

To decrease the color saturation, set it toward the minus end.

The closer it is to **-**, the lighter the colors will look.

To increase the color saturation, set it toward the plus end. The closer it is to **+**, the more saturated the colors will look.

Color tone

The skin tones can be adjusted.

To make the skin tone redder, set it toward the minus end. The closer it is to **-**, the redder the skin tone will look.

To make the skin tone less red, set it toward the plus end. The closer it is to **+**, the more yellow the skin tone will look.



- By selecting [**Default set.**], you can revert the respective Picture Style to its default parameters.
- To apply the adjusted Picture Style, follow step 2 to select the desired Picture Style and press the <MENU> button. Or follow step 1 on page 63 to select a Picture Style.

Monochrome Adjustment

For Monochrome, you can also set [Filter effect] and [Toning effect] in addition to [Sharpness] and [Contrast].

Filter effect

With a Filter effect applied to a monochrome image, you can make white clouds or green trees stand out more.

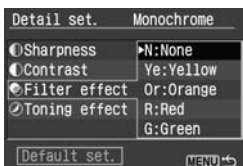

Filter	Sample effects
N: None	Normal black-and-white image with no filter effects.
Ye: Yellow	The blue sky will look more natural, and the white clouds will look crisper.
Or: Orange	The blue sky will look slightly darker. The sunset will look more brilliant.
R: Red	The blue sky will look quite dark. Fall leaves will look crisper and brighter.
G: Green	Skin tones and lips will look fine. Tree leaves will look crisper and brighter.

Setting the [Contrast] to the plus side will make the filter effect more pronounced.

Toning effect

By applying a toning effect, you can create a monochrome image in that color. It can make the image look more impressive.

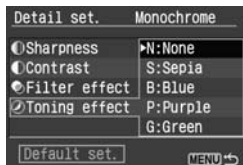

The following can be selected: [N:None] [S:Sepia] [B:Blue] [P:Purple] [G:Green]

MENU Defining a New Picture Style ★

You can select a base Picture Style such as [Portrait] or [Landscape], adjust its parameters as desired and register it in User Defined 1 to 3. You can set and save up to three Picture Styles whose parameters such as sharpness and contrast can be adjusted as desired. You can also select a Picture Style already set with the provided software.

1 Select [Picture Style].

- Under the [P2] tab, select [Picture Style], then press <SET>.
- ▶ The Picture Style selection screen will appear.

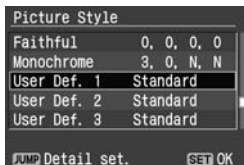

2 Select [User Def.].

- Press the <▲▼> key to select [User Def. 1/2/3], then press the <JUMP> button.
- ▶ The Detail set. screen will appear.

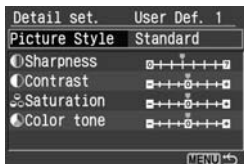

3 Press <SET>.

- With [Picture Style] selected, press <SET>.

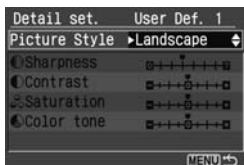

4 Select the base Picture Style.

- Press the <▲▼> key to select the base Picture Style, then press <SET>.
- If you have a Picture Style already set with the provided software, select it here.

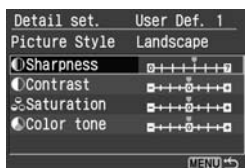

5 Select the parameter.

- Press the <▲▼> key to select a parameter such as [**Sharpness**], then press <SET>.

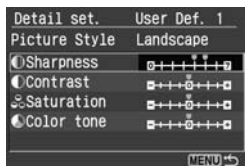

6 Adjust the parameter.

- Press the <◀▶> key to adjust the parameter as desired, then press <SET>.

For details, see “Customizing the Picture Style” on pages 78-80.



- Press the <MENU> button to register the new Picture Style. The Picture Style selection screen will then reappear.
- ▶ The base Picture Style will be displayed on the right of [**User Def. 1/2/3**].
- ▶ The name of the Picture Style having any modified settings (different from the default) registered in the [**User Def. 1/2/3**] will be displayed in blue.



- If a Picture Style has already been registered under [**User Def. 1/2/3**], changing the base Picture Style in step 4 will nullify the parameters of the registered Picture Style.
- To apply the registered Picture Style, follow step 2 to select the desired [**User Def. 1/2/3**] Picture Style and press the <MENU> button. Or follow step 1 on page 63 to select [**User Def. 1/2/3**].

MENU Setting the Color Space ★

The color space refers to the range of reproducible colors. With this camera, you can set the color space for captured images to sRGB or Adobe RGB. For normal images, sRGB is recommended. In the Basic Zone modes, sRGB is set automatically.

1 Select [Color space].

- Under the [CAM2] tab, select [Color space], then press < (SET) >.



2 Set the desired color space.

- Select [sRGB] or [Adobe RGB], then press < (SET) >.

About Adobe RGB

This is mainly used for commercial printing and other industrial uses. This setting is not recommended if you do not know about image processing, Adobe RGB, and Design rule for Camera File System 2.0 (Exif 2.21).

Since the image will look very subdued with an sRGB personal computer environment and printers not compatible with Design rule for Camera File System 2.0 (Exif 2.21), post-processing of the image with software will be required.



- If the image is captured with the color space set to Adobe RGB, the file name will start with “_MG_” (first character is an underscore).
- The ICC profile is not appended. The ICC profile is explained in the Software Instruction Manual (PDF).

* AE Lock *

Use AE lock when you want to take multiple shots at the same exposure setting or when the area of focus is to be different from the exposure metering area. Press the < * > button to lock the exposure, then recompose and take the shot. This is called AE lock. It is effective for backlit subjects.

1 Focus the subject.

- Press the shutter button halfway.
- ▶ The exposure setting will be displayed.

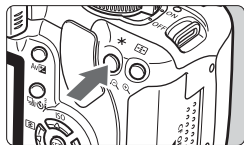

2 Press the < * > button. (1/4)

- ▶ The < * > icon lights in the viewfinder to indicate that the exposure setting is locked (AE lock).
- Each time you press the < * > button, it locks the current auto exposure setting.



AE lock indicator

3 Recompose and take the picture.

- If you want to maintain the AE lock while taking more shots, hold down the < * > button and press the shutter button to take another shot.

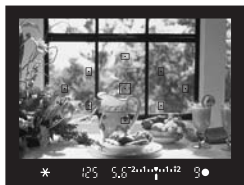

The AE lock effect will differ depending on the AF point and metering mode. For details, see “AE Lock” (p.159).

✳ FE Lock★

FE lock locks the flash exposure setting over the desired area of the subject. This feature also works with external EX-series Speedlites.

* FE stands for Flash Exposure.

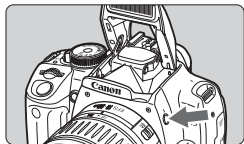

1 Press the <⚡> button to pop-up the built-in flash.

- Press the shutter button halfway and look in the viewfinder to check that the <⚡> icon is lit.



2 Focus the subject.

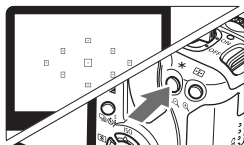

3 Press the <✳> button. (⊙16)

- Aim the viewfinder center over the subject where you want to lock the flash exposure, then press the <✳> button.
 - ▶ The flash will fire a preflash and the required flash output is calculated and retained in memory.
 - ▶ In the viewfinder, "FEL" is displayed for a moment and <⚡*> will light.
- Each time you press the <✳> button, a preflash is fired and the required flash output is calculated and retained in memory.



4 Take the picture.

- Frame the shot and press the shutter button completely.
 - ▶ The flash is fired to take the picture.



⚠ If the subject is too far away and beyond the effective range of the flash, the <⚡> icon will blink. Get closer to the subject and repeat steps 2 to 4.

WB: Setting the White Balance ★

White balance (WB) is for making the white areas look white instead of having a color cast. Normally, the <AWB> (Auto) setting will set the correct white balance automatically. If natural-looking colors cannot be obtained with <AWB>, you can set the white balance manually to suit the respective light source. In the Basic Zone modes, <AWB> will be set automatically.

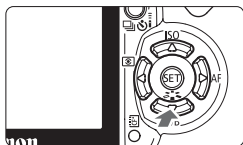

1 Press the <▼ WB> button.

▶ [White balance] will appear.

2 Select the white balance.

- Press the <◀▶> key to select the desired white balance setting, then press the shutter button halfway.
- The “Approx. ****K” (K: Kelvin) displayed for the selected white balance <☀> <🏠> <☁> <🌙> <🔦> is the respective color temperature.

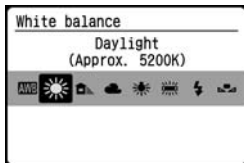

📷 Custom White Balance

Custom white balance enables you to manually set the white balance for a specific light source for better accuracy. Do this procedure under the actual light source to be used.

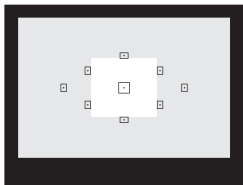

1 Photograph a white object.

- The plain, white object should fill the viewfinder center.
- Focus manually and set the correct exposure for the white object.
- You can set any white balance.



2 Select [Custom WB].

- Under the [📷2] tab, select [Custom WB], then press <SET>.
- ▶ The SET screen will appear.

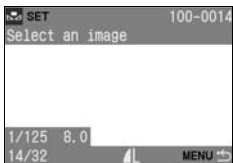

3 Import the white balance data.

- Select the image that was captured in step 1, then press <SET>.
- ▶ The data will be imported and the message screen and menu will reappear.

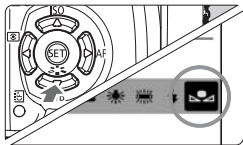

4 Select the custom white balance.

- Press the <▼ WB> button.
- Press the <◀▶> key to select <📷>, then press the shutter button halfway.



- If the exposure obtained in step 1 is way off, a correct white balance might not be obtained.
- If the image was captured while the Picture Style was set to [Monochrome] (p.64), it cannot be selected in step 3.



Instead of a white object, an 18% gray card (commercially available) can produce a more accurate white balance.

MENU White Balance Correction★

You can correct the white balance that has been set. This adjustment will have the same effect as using a color temperature conversion or color compensating filter. Each color can be corrected to one of nine levels.

Users familiar with using color temperature conversion or color compensating filters will find this feature handy.



1 Select [WB SHIFT/BKT].

- Under the [M2] tab, select [WB SHIFT/BKT], then press <SET>.
- ▶ The WB correction/WB bracketing screen will appear.

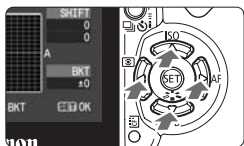

2 Set the white balance correction.

- Press the <◀▶> key to move the “■” mark to the desired position.
- B is for blue, A is amber, M is magenta, and G is green. The color balance will shift in the respective direction.
- On the upper right, “SHIFT” indicates the color balance bias and correction amount.
- To cancel the white balance correction, press the <◀▶> key to move the “■” mark to the center so that “SHIFT” indicates “0, 0.”
- Press <SET> to exit the setting and return to the menu.

Sample setting: A2, G1

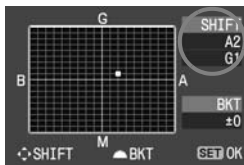

- During the white balance correction, <WB ±/±> will be displayed in the viewfinder and on the LCD monitor.
- One level of the blue/amber correction is equivalent to 5 mireds of a color temperature conversion filter. (Mired: A measurement unit indicating the density of a color temperature conversion filter.)

White Balance Auto Bracketing

With just one shot, three images having a different color tone can be recorded simultaneously. Based on the white balance mode's standard color temperature, the image will be bracketed with a blue/amber bias or magenta/green bias. This is called white balance bracketing. White balance bracketing is possible up to ± 3 levels in single-level increments.

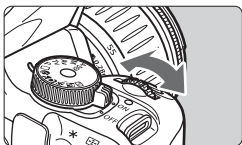

B/A bias ± 3 levels

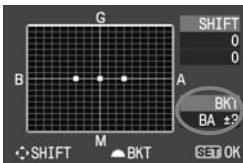

Set the white balance bracketing amount.

- In step 2 for white balance correction, when you turn the dial, the “■” mark on the screen will change to “■■■” (3 points). Turning the dial to the right sets the B/A bracketing, and turning it to the left sets the M/G bracketing.
- ▶ On the right side of the screen, “BKT” indicates the bracketing direction and the bracketing amount is also displayed.
- Press to exit the setting and return to the menu.
- To cancel the bracketing, set “BKT” to “±0” (“■■■” to “■” (1 point)).

Bracketing Sequence

Correct white balance, blue bias, and amber bias. Or, correct white balance, magenta bias, and green bias.



If the image-recording quality is set to RAW or RAW+ , white balance bracketing cannot be used.



- With white balance bracketing set, the maximum burst will be fewer during continuous shooting. The number of possible shots will also decrease to about one-third the normal number.
- Since three images are recorded for one shot, the CF card will take longer to record the shot.
- “BKT” stands for Bracketing.

Preventing Camera Shake

To prevent camera shake, using a tripod is effective. When pressing the shutter button, do it carefully without shaking the camera. Preventing camera shake while you press the shutter button on a tripod-mounted camera is explained below.

Using Remote Control to Shoot

Using Remote Switch RS-60E3 or Remote Controller RC-1/RC-5 (both optional) can prevent camera shake and enable remote shooting.

Remote Switch RS-60E3

Remote switch with a 60 cm/2.0 feet cord for pressing the shutter button halfway or fully. It connects to the camera's remote control terminal.

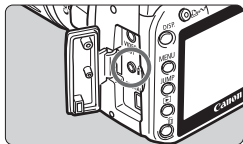

Remote Controller RC-1/RC-5

Remote controller to shoot wirelessly up to about 5 meters/16.4 feet from the camera. (p.153) The RC-1 can trip the shutter immediately or after a 2-sec. delay, and the RC-5 trips the shutter after a 2-sec. delay.



RC-1



RC-5

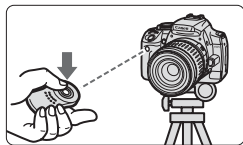

Mirror Lockup

Although remote control shooting can prevent camera shake, using mirror lockup to prevent camera vibrations can also help when you use a super telephoto lens or shoot close ups. Mirror lockup is enabled by accessing [**F2 Custom Function (C.Fn)**] and setting [**Mirror lockup**] (p.105) to [**1:Enable**].

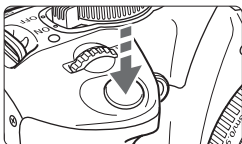

- Press the shutter button completely to lockup the reflex mirror.
- Then press the shutter button completely again to take the picture. The reflex mirror will then go back down.



Shooting Tips

- **Do not point the camera toward the sun.**
The sun's heat can scorch and damage the shutter curtains.
- **With the self-timer, the picture can be taken after a 2-sec. delay.**
When you press the shutter button completely, the mirror locks up, then the picture is taken 2 sec. later. For bulb exposures, hold down the shutter button until you want to end the exposure. If you let go of the shutter button during the 2-sec. self-timer countdown, there will be a shutter-release sound. This is not the actual shutter release (no picture is taken).
- **Remote control shooting**
Since you do not touch the camera when the picture is taken, remote control shooting together with mirror lockup can further prevent camera shake. With Remote Controller RC-5, pressing the transmit button locks up the mirror before the shot is taken 2 sec. later. With RC-1, set it to 2-sec. delay, then shoot.



- If (Continuous shooting) has been set, single shooting will still take effect.
- The mirror locks up, and after 30 seconds, it will go back down automatically. Pressing the shutter button completely again locks up the mirror again.



5

Handy Features

This chapter introduces convenient everyday features such as silencing the beeper and preventing shooting without a CF card installed.

It also teaches how to customize camera functions to suit your preferences, transfer images directly to a personal computer, and prevent dust from appearing on your images.

Handy Features

MENU Silencing the Beeper

You can prevent the beeper from sounding when focus is achieved or during self-timer operation.

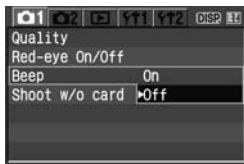

Under the [**01**] tab, select [**Beep**], then press < **SET** >. Select [**Off**], then press < **SET** >.

MENU CF Card Reminder

This prevents shooting if there is no CF card in the camera.

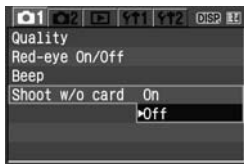

Under the [**01**] tab, select [**Shoot w/o card**], then press < **SET** >. Select [**Off**], then press < **SET** >.

If there is no CF card installed and you press the shutter button, “no CF” will be displayed in the viewfinder, and you cannot release the shutter.

MENU Setting the Image Review Time

How long the image is displayed on the LCD monitor immediately after capture can be set. If [**Off**] is set, the image review will not be displayed. If [**Hold**] is set, the image review will be displayed up until the [**Auto power off**] time. The LCD monitor display will turn off if you put your eye near the viewfinder, press the shutter button, or do any camera operation.



Under the [**02**] tab, select [**Review time**], then press < **SET** >. Set the time, then press < **SET** >.

MENU Set the Auto Power-off Time

To save battery power, the camera turns off automatically after the set time of idle operation elapses. You can set this auto power-off time. When the camera has turned off due to auto power off, you can wake up the camera by pressing the shutter button, <MENU>, <DISP.>, or <▶> button.

If [Off] has been set, either turn off the camera yourself or press the <DISP.> button to turn off the camera settings display to save battery power. If [Off] has been set and the camera is not used for 30 min., the LCD monitor will turn off automatically. To turn on the LCD monitor again, press the <DISP.> button.

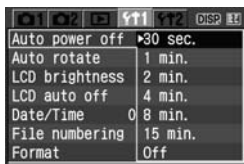

Under the [fT1] tab, select [Auto power off], then press <SET>. Set the time, then press <SET>.

MENU Setting the LCD Monitor Brightness

You can adjust the brightness of the LCD monitor to make it easier to read.



Under the [fT1] tab, select [LCD brightness], then press <SET>. With the adjustment screen displayed, press the <◀▶> key to adjust the brightness, then press <SET>.



When checking the exposure of an image, prevent the ambient light from affecting the reviewed image. Also, setting the LCD monitor brightness at the center of the adjustment scale is recommended.

MENU File Numbering Method

The file number is like the frame number on a roll of film. The captured images are assigned a sequential file number from 0001 to 9999 and saved in one folder. You can also change how the file number is assigned.

The file number will appear on the personal computer in this format:
IMG_0001.JPG.

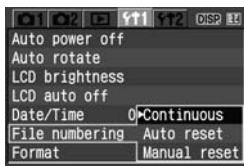

Under the [**FILE**] tab, select [**File numbering**], then press <SET>. Follow the steps below to select a file numbering method, then press <SET>.

- **[Continuous]: The file numbering continues in sequence even after the CF card is replaced.**

Even after you replace the CF card, the file numbering continues in sequence up to 9999. This is convenient when you want to save the images numbered anywhere between 0001 to 9999 in one folder in your personal computer.

If the replacement CF card contains images recorded previously, the file numbering of the new images might continue from the file numbering of the existing images in the card. If you want to use continuous file numbering, you should use a newly-formatted CF card each time.

File numbering after replacing the CF card

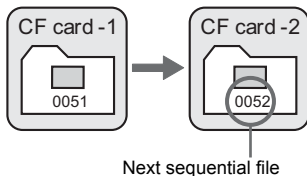

- **[Auto reset]: Resets the file numbering to 0001 whenever the CF card is replaced.**

Each time the CF card is replaced, the file numbering starts from 0001. This is convenient if you want to organize images according to CF cards.

If the replacement CF card contains images recorded previously, the file numbering of the new images might continue from the file numbering of the existing images in the card. To start the file numbering from 0001, the CF card must be formatted before use.

File numbering after replacing the CF card

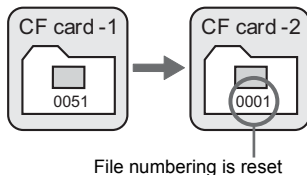

- **[Manual reset]: You can reset the file numbering 0001 at any time or for a new folder.**

When you reset the file numbering manually, a new folder is created automatically and the file numbering of images saved to that folder starts from 0001. This is convenient when you want to use different folders for the images taken yesterday and the ones taken today. After the manual reset, the file numbering returns to continuous or auto reset.

ⓘ If folder No. 999 is created, **[Folder number full]** will appear on the LCD monitor. If that folder contains images reaching file number 9999, shooting will not be possible even if the CF card still has storage capacity. The LCD monitor will display a message to replace the CF card. Be sure to replace the CF card.

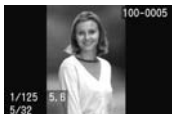

📄 For both JPEG and RAW images, the file name will start with "IMG_". The file name extension will be ".JPG" for JPEG images and ".CR2" for RAW images.

MENU Auto Rotate of Vertical Images

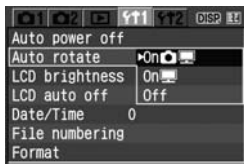

Vertical images are rotated automatically so they are displayed vertically on the camera's LCD monitor and personal computer instead of horizontally. The setting of this feature can be changed.



Under the [**F1**] tab, select [**Auto rotate**], then press <[**SET**]>. See the descriptions of the settings below and select the desired setting. Then press <[**SET**]>.

- [**On** ]: The vertical image is automatically rotated on both the camera's LCD monitor and on the personal computer.
- [**On** ]: The vertical image is automatically rotated only on the personal computer.
- [**Off**]: The vertical image is not automatically rotated at all.

? FAQ

- **The vertical image is not rotated during the image review immediately after it is captured.**
The vertical image is rotated only for playback.
- **[On ] is set, but the image does not rotate during playback.**
Auto rotate will not work with vertical images captured while [**Auto rotate**] was set to [**Off**]. Also, if the vertical image is taken while the camera is pointed up or down, the image might not rotate for playback. In such a case, see "Rotating the Image" on page 119.
- **Rotating an image on the camera's LCD monitor when [On ] had been set.**
Set [**On** ], then playback the image. It will be rotated.
- **The vertical image does not rotate on the personal computer screen.**
The software used is not compatible with image rotation. Use the camera's bundled software instead.

DISP. Checking Camera Function Settings

While the menu is displayed, press the <DISP.> button to display the camera's current settings.

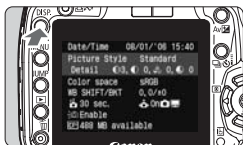

- While the menu is displayed, press the <DISP.> button to display the settings.
- Press the <DISP.> button again to return to the menu.
- Press the shutter button halfway to return to the camera setting display.

Camera Function Setting Display

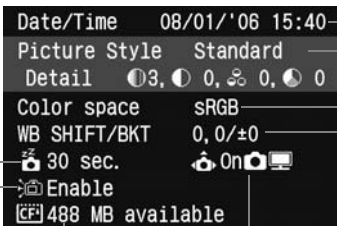

— Date/Time (p.37)

— Picture Style (p.63)

— Color space (p.83)

— WB correction (p.88)/
WB bracketing (p.89)

— Auto rotate display (p.98)

— CF card remaining capacity

— LCD monitor auto off (p.101)

— Auto power off (p.95)

MENU Reverting the Camera to the Default Settings*

This is for returning all the camera's shooting settings and Custom Functions to the default. This works in the <P> and other Creative Zone modes.

1 Select [Clear settings].

- Under the [fT2] tab, select [Clear settings], then press <SET>.

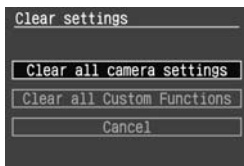
**2 Select the desired option.**

- To revert the camera to the default settings, select [Clear all camera settings], then press <SET>.
- To revert the Custom Functions to the default settings, select [Clear all Custom Functions], then press <SET>.

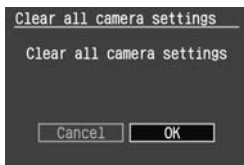
**3 Select [OK].**

- Select [OK], then press <SET> to clear the Custom Functions.
- ▶ When [Clear all camera settings] is set, the camera will be reset to the following settings.

Shooting Settings





AF mode	One-Shot AF
AF point selection	Automatic AF point selection
Metering mode	 (Evaluative metering)
Drive mode	 (Single shooting)
Exposure compensation	0 (Zero)
AEB	Canceled
Flash exposure compensation	0 (Zero)

Image-Recording Settings

Quality	 L
ISO speed	100
Color space	sRGB
White balance	 (Auto WB)
WB correction	Canceled
WB bracketing	Canceled
Picture Style	Standard

* The white balance data (p.86) obtained from the custom white balance and the Dust Delete Data (p.112) will be erased.

MENU Preventing the LCD Monitor from Turning off Automatically

This prevents the display-off sensor from turning off the camera settings display automatically when your eye nears the viewfinder.

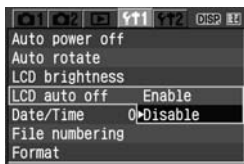

Select [LCD auto off].

- Under the [**Fn1**] tab, select [**LCD auto off**], then press <SET>. Select [**Disable**], then press <SET>.

MENU Setting Custom Functions★

You can customize various camera features to suit your picture-taking preferences. You can do it with Custom Functions. Custom Functions can be set and used only in Creative Zone modes.

MENU Setting a Custom Function★

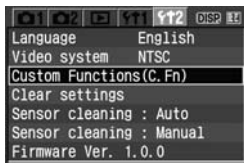

1 Select [Custom Functions (C.Fn)].

- Under the [**Fn2**] tab, select [**Custom Functions (C.Fn)**], then press <SET>.
- ▶ The Custom Function screen will appear.

Custom Function No.



2 Select the Custom Function No.

- Press the <◀▶> key to select the number of the Custom Function to be set, then press <SET>.

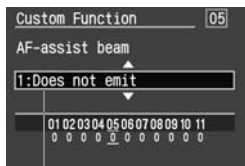

Description

3 Change the setting.

- Press the <▲▼> key to select the desired setting (number), then press <SET>.
- Repeat steps 2 and 3 if you want to set other Custom Functions.
- At the bottom of the screen, the current Custom Function settings are indicated below the respective Custom Function numbers.

4 Exit the menu.

- Press the <MENU> button to return to the menu.
- When you press the shutter button halfway, the **C.Fn** is displayed on the LCD monitor to indicate that a Custom Function has been set.

Clearing All Custom Functions

On the [**Y/T2 Clear settings**] menu, select [**Clear all Custom Functions**] to reset all the Custom Functions to the default settings. (p.100)

MENU Custom Function Settings *

C.Fn-1 SET button/Cross keys funct.

You can assign often-used functions to the SET button and cross keys.

0: SET:Picture Style

Press <SET> to display the Picture Style selection screen on the LCD monitor. When the menu is displayed, this is used for the menu function settings.

1: SET:Quality

When you press <SET>, the recording quality setting screen appears so you can quickly change the setting.

2: SET:Flash exp comp

When you press <SET>, the flash exposure compensation screen appears so you can quickly change the setting.

3: SET:Playback

When you press <SET>, the images recorded in the CF card will be played back. Assigns the same function as the <▶> button.

4: Cross keys:AF frame selec.

After you press the shutter button halfway (ⓘ4), you can press the <⬆> key to select the AF point. The AF point selection screen will not be displayed. Select the AF point while looking at the AF point selection display.



To set automatic AF point selection, press the <Ⓜ> button. Also, to select the center AF point, press <SET>.

If you want to change the ISO speed or other setting assigned to the <⬆> key, press the button while the shutter speed and aperture are not displayed. If you press the button while the shutter speed and aperture are displayed, the setting screen will not appear.

C.Fn-2 Long exp. noise reduction

This is effective for minimizing noise in images exposed for 1 sec. or longer.

0: Off**1: Auto**

For 1 sec. or longer exposures, noise reduction is performed automatically if noise peculiar to long exposures is detected. This [Auto] setting is effective in most cases.

2: On

Noise reduction is performed for all exposures 1 sec. or longer. This setting may be effective for noise that cannot be detected or reduced with the [Auto] setting.



After the picture is taken, the noise reduction process will take the same amount of time as the exposure. You cannot take another picture until the noise reduction process is completed.

C.Fn-3 Flash sync. speed in Av (Aperture-priority AE) mode

0: Auto

The flash sync speed is set automatically within a range of 30 sec. to 1/200 sec. to suit the scene's brightness.

1: 1/200sec. (fixed)

The flash picture can be taken without camera shake.

C.Fn-4 Shutter/AE lock button

0: AF/AE lock

1: AE lock/AF

Convenient when you want to focus and meter separately. Press the <✳> button to autofocus and press the shutter button halfway to attain AE lock.

2: AF/AF lock, no AE lock

In the AI Servo AF mode, you can press the <✳> button to stop the AF operation momentarily. This prevents the AF from being thrown off by any obstacle passing between the camera and subject. The exposure is set at the moment the picture is taken.

3: AE/AF, no AE lock

This is useful for subjects which keep moving and stopping repeatedly. In the AI Servo AF mode, you can press the <✳> button to start or stop the AI Servo AF operation. The exposure is set at the moment the picture is taken. Thus, the focusing and exposure will always be at the optimum point as you wait for the decisive moment.

C.Fn-5 AF-assist beam

You can enable or disable the camera's AF-assist beam or have it emitted by the EOS-dedicated Speedlite instead.

0: Emits

1: Does not emit

The AF-assist beam is not emitted at all regardless of the shooting conditions. This can prevent the AF-assist beam from disturbing another photographer's shooting.

2: Only external flash emits

With an EOS-dedicated Speedlite, it will emit the AF-assist beam when necessary.

C.Fn-6 Exposure level increments**0: 1/3-stop****1: 1/2-stop**

Sets 1/2-stop increments for the shutter speed, aperture, exposure compensation, AEB, etc. Effective when you prefer to control the exposure in less fine increments.



The exposure level will be displayed in the viewfinder and on the LCD monitor as shown below.

**C.Fn-7 Mirror lockup****0: Disable****1: Enable**

Effective for telephoto and close-up shots to prevent camera shake caused by the mirror's reflex action.

C.Fn-8 E-TTL II**0: Evaluative**

Fully automatic flash photography for all conditions, from low light to daytime fill-flash.

1: Average

Geared for advanced users who want to control the external Speedlite, this mode averages the entire flash metering area. Since the camera will not execute automatic exposure compensation, adjust the flash exposure compensation if necessary.

C.Fn-9 Shutter curtain sync.

0: 1st-curtain sync.

The flash fires immediately after the shot is exposed.

1: 2nd-curtain sync.

The flash fires immediately before the exposure ends. This creates a light trail following the moving subject such as a car at night.

 When 2nd-curtain sync is set, a flash is fired twice: First when you press the shutter button completely, and again immediately before the exposure ends.

C.Fn-10 Magnified view

0: Image playback only (p.118)

1: Image review and playback

To see a magnified view during the image review immediately after shooting, hold down the $\langle \text{DISP} \rangle$ button and press the $\langle \text{Q} \rangle$ button. During the magnified view, you can magnify or reduce the view with the $\langle \text{Q} \rangle$ and $\langle \text{Q} \rangle$ buttons. To magnify the playback image with the $\langle \text{▶} \rangle$ button, press the $\langle \text{Q} \rangle$ button.

C.Fn-11 LCD display when power ON

0: Display

When the power switch is turned on, the camera settings will be displayed.

1: Retain power OFF status

If you pressed the $\langle \text{DISP} \rangle$ button to turn off the LCD monitor and then you turn off the power, the LCD monitor will not turn on when you turn on the power again. This helps to save battery power. If you press a button like $\langle \text{ISO} \rangle$ or $\langle \text{AF} \rangle$ which displays a setting screen on the LCD monitor, the respective setting screen will still appear. The menu screens and image playback will also still be displayed when used.

If you pressed the $\langle \text{DISP} \rangle$ button to turn on the LCD monitor and then you turn off the power, the LCD monitor will turn on when you turn on the power again.

 If C.Fn-1-4 has been set, first check that the viewfinder information has turned off before pressing $\langle \text{ISO} \rangle$, $\langle \text{AF} \rangle$, or other buttons. If the viewfinder information is still displayed and you press the button, the setting screen will not appear.

MENU Transferring Images to a Personal Computer ■

By connecting the camera to a personal computer, you can transfer images from the camera's CF card by operating the camera. This is called direct image transfer.

- ⓘ** Before connecting the camera to the personal computer, be sure to install the bundled software (EOS Digital Solution Disk/CD-ROM) in the personal computer.

For instructions on how to install the software, see "Software Guide."

Preparation for Image Transfer

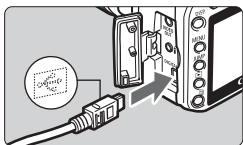

1 Connect the camera to the personal computer.

- Turn off the camera's power switch before connecting it.
- Use the USB cable provided with the camera to connect it to the personal computer.

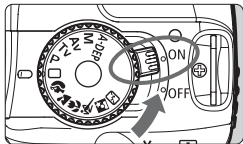

2 Set the camera's power switch to <ON>.

- When the program selection screen appears on the personal computer, select [**EOS Utility**]. When the camera model selection screen appears, select your camera's model.
- ▶ The [**EOS Utility**] screen will appear on the computer, and the [**Direct Transfer**] screen will appear on the camera's LCD monitor.

- ⓘ**
- While the direct transfer screen is displayed, pressing the shutter button halfway will not return the camera to shooting-ready.
 - Before disconnecting the cable, turn off the camera first and pull out the cable by grasping the plug (instead of the cord).

📄 If the [**EOS Utility**] screen does not appear on the computer, see "Connect the Camera and the Computer and then Start EOS Utility" in the Software Instruction Manual in the CD-ROM.

Transferring Images to a Personal Computer

The images sent to the personal computer will be saved in the **[My Pictures]** folder (Windows) or **[Pictures]** folder (Macintosh) in subfolders organized according to shooting date.

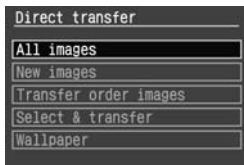

Transfer all the images in the CF card to the personal computer.

- Select **[All images]**, then press the <⏏> button.
- ▶ The <⏏> button's blue lamp will blink and the image transfer will start.
- ▶ When the image transfer is completed, the lamp will stay on.

Options other than **[All images]** are explained below. To start the image transfer, press the <⏏> button.

- **[New images]**

Images which have not yet been transferred to the personal computer will be selected by the camera automatically for the transfer.

- **[Transfer order images]**

You select the images to be transferred to the personal computer in a batch. To select the images, follow the instructions on the next page.

- **[Select & transfer]**



Press the <◀▶> key to select images one by one to be transferred to the personal computer. To exit, press the <MENU> button.

- **[Wallpaper]**

Press the <◀▶> key to select the image and transfer it. The image will then appear as wallpaper on the computer desktop screen. To exit, press the <MENU> button.



If you press <SET> instead of the <▶▶> button, the confirmation dialog will appear. Select [OK], then press <SET> to start the transfer.

Selecting the Images to be Transferred

You select the image to be transferred to the personal computer one by one.



1 Select [Transfer order].

- Under the [▶] tab, select [Transfer order], then press <SET>.
- ▶ The Transfer order screen will appear.



2 Select [Order].

- Select [Order], then press <SET>.
- ▶ An image will appear.



3 Select the image to be transferred.

- Press the <◀▶> key to select an image, then press the <▲▼> key to place a checkmark <√> on the upper left.
- Repeat this step for all the images you want to transfer. You can select up to 998 images to be transferred.

- Press the <MENU> button twice to save the image selections to the CF card. The menu screen will then reappear.

About [All]

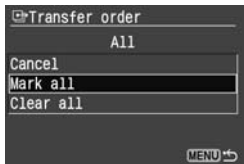

In step 2, when you select **[All]**, the screen on the left will appear. If you then select **[Mark all]** and press <SET>, up to 998 images will be transferred in one batch.

If you select **[Clear all]** and press <SET>, all your image selections for transfer will be canceled.

! Do not insert into the camera a CF card whose transfer order was set by a different camera and then try to specify another transfer order. The selected images might all be overwritten. Also, depending on the image type, the transfer order may not be possible.

- i** ● If a RAW+JPEG image is selected for transfer, it will be counted as one image even though both the RAW and JPEG images will be transferred to the personal computer.
- In step 3, press the <Q> button to see a three-image display. To return to the single-image view, press the <Q> button.

MENU Automatic Sensor Cleaning

When you turn the camera's power switch on or off, the Self Cleaning Sensor Unit operates to automatically remove dust adhering to the imaging sensor. You normally need not pay attention to this feature. However, if you want to activate this self-cleaning manually or disable it, follow the instructions below.

Manual self-cleaning

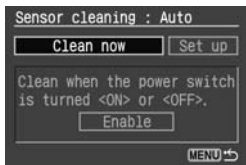

Select [Sensor cleaning: Auto].

- Under the [F2] tab, select [Sensor cleaning: Auto], then press <SET>.
- With [Clean now] selected, press <SET>. The self-cleaning will be performed for about 1 sec., then the menu will reappear.



- For maximum effectiveness, set the camera upright horizontally (do not tilt up or down) before executing [Clean now].
- If [Clean now] is grayed out and cannot be selected, wait a while until it is selectable.

Disabling automatic sensor cleaning

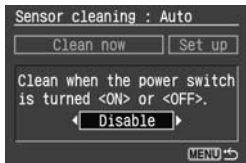

- With the screen above displayed, press the <◀▶> key to select [Set up], then press <SET>.
- Press the <◀▶> key to select [Disable], then press <SET>.

To minimize dust from entering the camera, note the following countermeasures:

- When changing lenses, do it in a place with minimal dust.
- When storing the camera without a lens attached, be sure to attach the body cap.
- Clean the body cap before attaching it.

MENU Appending Dust Delete Data ★

Normally, the Self Cleaning Sensor Unit will eliminate most of the dust visible on captured images. However, in case visible dust still remains, you can append Dust Delete Data to the image to later erase the dust spots. The Dust Delete Data is used by the Digital Photo Professional program (provided) to erase the dust spots automatically.

Preparation

- Get a solid-white object (paper, etc.).
- Set the lens focal length to 50mm or longer.
- Set the lens focus mode switch to **<MF>** and set the focus to infinity (∞). If the lens has no distance scale, look at the front of the lens and turn the focusing ring clockwise all the way.

Obtain the Dust Delete Data

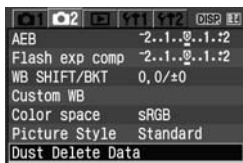

1 Select [Dust Delete Data].

- Under the [**02**] tab, select [**Dust Delete Data**], then press **<SET>**.
- ▶ The Dust Delete Data screen will appear.

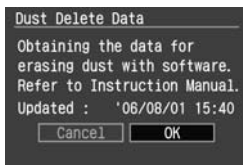

2 Select [OK].

- Select [**OK**] and press **<SET>**. The automatic self-cleaning of the sensor will be performed, then a message screen will appear.

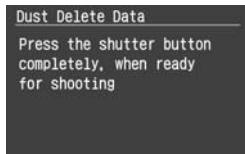

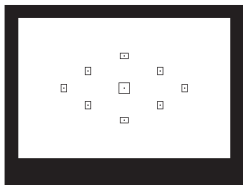

3 Photograph a solid-white object.

- Keep a distance of 20 - 30 cm / 0.7 - 1.0 feet and fill the viewfinder completely with the white object. Then take the picture.
- ▶ The picture will be taken in the aperture-priority mode with an aperture of f/22.
- Since the captured image will not be saved, installing a CF card in the camera is not necessary. The image data will still be obtained.
- ▶ After the image is captured, the data is obtained. When it is completed, the "Data obtained" screen will appear. Select **[OK]** and press **<SET>**. The menu will reappear.

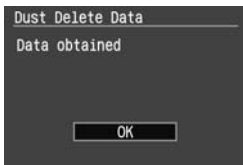

About the Dust Delete Data

After the Dust Delete Data is obtained, it is appended to all the JPEG or RAW images captured thereafter. The data will also be appended to images taken in the Basic Zone modes. Before an important shoot, you should update the Dust Delete Data by obtaining it again.

Regarding the automatic dust erasure with the bundled software, see the Software Instruction Manual in the CD-ROM.

The Dust Delete Data appended to the image is so small that it hardly affects the image file size.

MENU About “Sensor cleaning: Manual” ★

Under the [fT2] tab, [Sensor cleaning: Manual] is mainly for use by Canon service personnel. Dust which could not be eliminated by the Self Cleaning Sensor Unit can be directly cleaned off the sensor.

Therefore, you normally need not use this feature.

The surface of the imaging sensor is extremely delicate. If the sensor needs to be cleaned directly, have it done by a Canon Service Center.

However, if you want to clean the sensor yourself, follow the procedure below:

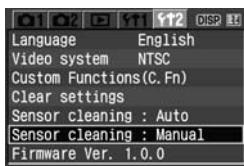

1 Select [Sensor cleaning: Manual].

- Under the [fT2] tab, select [Sensor cleaning: Manual], then press <SET>.

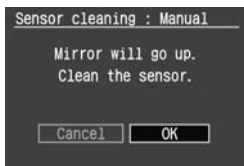

2 Select [OK].

- Select [OK], then press <SET>.
- ▶ In a moment, the mirror will lockup and the shutter will open to expose the sensor. You can now clean the sensor.

3 Exit the cleaning.

- Set the power switch to <OFF>.

- ⚠ ● While cleaning the sensor, never do any of the following. If the power is cut off, the shutter will close and it may damage the shutter curtains and imaging sensor.
 - Setting the power switch to <OFF>, opening the CF card slot cover, or opening the battery compartment cover.
- Never use canned air or gas to clean the sensor.
- For the power source, using the AC Adapter Kit (p.154) is recommended. If you use a battery, make sure it is fully recharged.

6

Image Management

This chapter explains features related to viewing images. Learn more about image playback as discussed in chapter 2 “Basic Shooting and Image Playback” and how to view images on a TV set. You can also erase images.

For images taken with another camera:

The camera might not be able to display images captured with a different camera or edited with a personal computer or whose file name has been changed.

▶ Searching for Images Quickly

▣ Display 9 Images on One Screen (Index display)

The index display enables faster image searching.

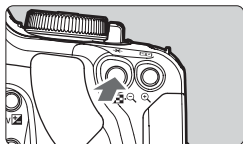

1 Enable the index display.

- During image playback, press the <▣·Q> button to display the index display.
- ▶ The selected thumbnail will be highlighted with a green frame.



2 Select the image.

- Press the <◊> key to move the green frame in the respective direction.
- Press the <Q> button to enlarge the selected image as a single-image display.

Quick Image Search with the Index Display

With the index display, you can view nine images at a time.



1 Press the <JUMP> button.

- ▶ All nine thumbnails will be highlighted with a green frame.

2 See the next screen.

- Press the <◀▶> key to go to the next or previous nine images.

3 Select an image.

- Press the <JUMP> button and only one image will be highlighted in green. Then press the <◊> key to select any image.

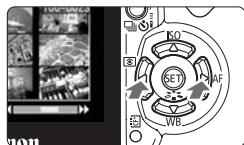

JUMP: Jump through Images

When the CF card contains many images, you can browse through them by 10 or 100 images at a time. Also, if the images were shot on different days, you can browse through them by date. This browsing technique is called Jump.

Jump method



Jump bar

1 Go to the jump display.

- During image playback, press the <JUMP> button.
- ▶ On the bottom of the screen, you can see the jump bar.

2 Select the jump method.

- Press the <▲▼> key to select the jump method (📅 Jump 10 images / 📅 Jump 100 images / 📅 Jump shot date).

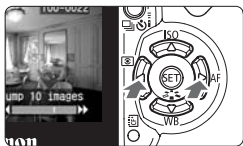

3 Browse by jumping.



- Press the <◀▶> key to browse through the images via the jump method you selected.
- To quit the image jump, press the <JUMP> button. The jump mode will end.

Magnified View

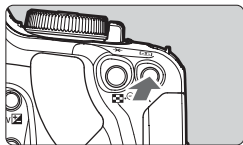
You can magnify the image by 1.5x to 10x on the LCD monitor.





1 Magnify the image.

- During image playback, press the  button to magnify the image.
- To increase the magnification, hold down the  button.
- Press the  button to reduce the magnification. If you hold down the button, the image will continue to reduce until it reaches the size before it was magnified.





Magnified area

2 Scroll around the image.

- Press the  key to scroll around in the respective direction.
- To exit the magnified display, press the  button and the single-image display will return.

Magnified View Tips



The magnified view can be maintained when you see the next or previous image.

- When you turn the  dial, you can view another image without the magnification changing.
- Press the **<JUMP>** button, then press the  key to jump by 10 images.

Magnified view is possible from the index display.

- Press the  button to display a single image. Press it again to display a magnified image.

Magnified view is also possible during the image review after shooting.

- If the [**T2 Custom Function (C.Fn)**] menu's [**Magnified view**] (p.106) is set to [**1: Image review and playback**], magnified view is possible with the  +  button. Pressing the  button will magnify the image.

MENU Rotating the Image

After taking the picture, you can rotate the image so it is displayed in the correct orientation.



1 Select [Rotate].

- Under the [] tab, select [Rotate], then press <SET>.
- ▶ An image will appear.



2 Select an image.

- Press the <◀▶> key to select the image to be rotated.
- You can also select an image on the index display.



3 Rotate the image.

- Each time you press <SET>, the image will rotate clockwise.
- To rotate other images, repeat steps 2 and 3.
- To exit the Rotate screen, press the <MENU> button. The menu will reappear.

To display the rotated images as rotated for playback

When [Auto rotate] on page 98 is set to [On], the image will be rotated for playback.



If you have set [Auto rotate] to [On] (p.98) before taking the vertical shots, you need not rotate the image as described above.

MENU Auto Playback

You can playback the CF card's images in an automatic slide show. Each image will be displayed for about 4 sec.



1 Select [Auto Play].

- Under the [▶] tab, select [**Auto play**], then press <SET>.
- ▶ The auto play screen will appear.



2 Start the auto play.

- ▶ After [**Loading image...**] is displayed for a few seconds, auto play will start.
- To pause the auto play, press <SET>.
- During pause, [||] will be displayed on the upper left of the image. Press <SET> again to resume the auto play.



3 Stop the auto play.

- To stop the auto play and return to the menu, press the <MENU> button.

- During auto play, you can press the <DISP.> button to change the display format.
- During pause, you can press the <◀▶> key to view another image.
- During auto play, auto power off will not work.
- The display time may vary depending on the image.

Displaying the Images on TV

With the video cable provided with camera, you can connect the camera to a TV set and view images on the TV screen. Always turn off the camera and the television before connecting or disconnecting them.

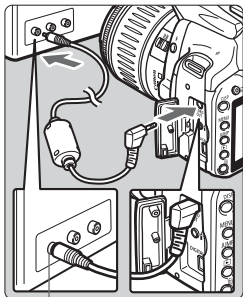

Video IN terminal

1 Connect the camera to the TV.

- Open the camera's terminal cover.
- Use the video cable (provided) to connect the camera's <VIDEO OUT> terminal to the TV monitor's VIDEO IN terminal.
- Insert the cable plug all the way in.

2 Turn on the TV and switch the TV's line input to Video IN.

3 Set the camera's power switch to <ON>.

- ▶ The camera's setting display will appear on the TV screen.

4 Press the <▶> button.

- ▶ The image will appear on the TV screen. (Nothing will be displayed on the camera's LCD monitor.)
- After you finish, set the power switch to <OFF>, turn off the TV, then disconnect the video cable.

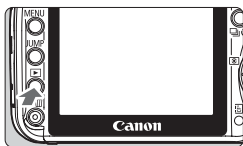

- If the proper video system format is not set, the image will not be displayed properly. Set the proper video system format with [**F12 Video system**].
- Do not use any video cable other than the one provided. Images might not be displayed if you use a different video cable.
- Depending on your TV or monitor, part of the image might be truncated.

MENU Protecting Images

This prevents the image from being erased accidentally.



1 Select [Protect].

- Under the [] tab, select [Protect], then press <SET>.
- ▶ An image will appear.

2 Select the image.

- Press the <◀▶> key to select the image to be erase-protected.
- You can also select an image on the index display.



Image protect

3 Protect the image.

- When you press <SET>, <[]> will appear at the bottom of the screen and the image will be erase-protected.
- To cancel the image protection, press <SET> again. The <[]> icon will disappear.
- To protect another image, repeat steps 2 and 3.
- To exit the image protection, press the <MENU> button. The menu will reappear.



- Once an image is protected, it cannot be erased by the camera's erase function. To erase a protected image, you must first cancel the erase protection.
- If you erase all the images (p.123), only the protected images will remain. This is convenient when you want to erase unnecessary images all at once.

Erasing Images

You can either select and erase images one by one or erase them in one batch. Protected images (p.122) will not be erased.

- ❗ **Once an image is erased, it cannot be recovered. Make sure you no longer need the image before erasing it. To prevent important images from being erased accidentally, protect them.**

1 Playback the image.

- To erase images one by one, press the <◀▶> key to select the image to be erased.



2 Display the erase menu.

- Press the <🗑️> button.
- ▶ The bottom of the screen shows how the image can be erased.



3 Erase the images.

- Select [Erase], then press <SET>. The image displayed will be erased.
- If you select [All] and press <SET>, all unprotected images will be erased.
- ▶ When the confirmation dialog appears and you select [OK] and press <SET>, the image(s) will be erased.



While all the images are being erased, you can cancel the erasure by pressing <SET>.

Shooting Information Display

When you press the <DISP.> button during single-image playback, you can switch to the shooting information display. The shooting information display shows the following.

Basic information display

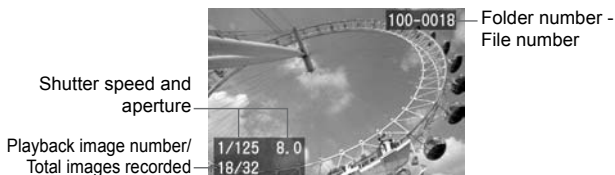

Shooting information display

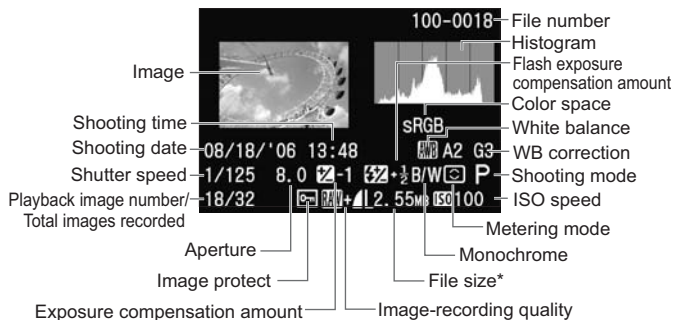

* With RAW+JPEG files, the JPEG file size is displayed.

● Highlight Alert

When the shooting information is displayed, the overexposed highlight areas will blink. To obtain more image detail in the overexposed areas, set the exposure compensation to a negative amount and shoot again.

 In image playback modes other than single image, such as index display and magnified view, you can still press the <DISP.> button to display or turn off the basic information.

● Histogram

The brightness histogram display shows the exposure level distribution, overall brightness and gradation. And the RGB histogram display is suited for checking the color saturation and gradation. The display can be switched with the [▶ Histogram] menu. Being able to analyze the histogram and using it to improve the next shot requires advanced knowledge and experience. Only a basic explanation is provided here.

Sample Histograms

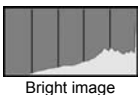
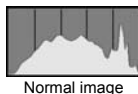

[Brightness] Display

This histogram is a graph showing the distribution of the image's brightness level. The horizontal axis indicates the brightness level (darker on the left and brighter on the right), while the vertical axis indicates how many pixels exist for each brightness level. The more pixels there are toward the left, the darker the image. And the more pixels there are toward the right, the brighter the image.

If there are too many pixels on the left, the shadow detail will be lost. And if there are too many pixels on the right, the highlight detail will be lost. The tones in-between will be reproduced.

By checking the image's brightness histogram, you can see the exposure level bias and the overall tone reproduction condition.

[RGB] Display

This histogram is a graph showing the distribution of the image's brightness level of each primary color (RGB or red, blue, and green). The horizontal axis indicates the color's brightness level (darker on the left and brighter on the right), while the vertical axis indicates how many pixels exist for each color brightness level. The more pixels there are toward the left, the darker and less prominent the color. And the more pixels there are toward the right, the brighter and denser the color. If there are too many pixels on the left, the respective color information will be lacking. And if there are too many pixels on the right, the color will be too saturated with no detail.

By checking the image's RGB histogram, you can see the color's saturation and gradation condition and white balance bias.



7

Printing Images

The camera can be connected directly to a PictBridge printer or to a CP Direct or Bubble Jet printer and print images.

You can select a number of pictures and print them all in one batch (DPOF). (p.144)

About DPOF

DPOF (Digital Print Order Format) is a standard for recording printing instructions (image selections, number of copies, etc.) in the CF card. In this way, you can print multiple pictures in one batch or give the printing order to a photofinisher.

Canon's PictBridge Web Site

The Web site below gives more information on using your Canon camera with various printers, such as which paper types to use.

<http://canon.com/pictbridge/>

Conventions Used in this Chapter

As shown below, this chapter includes procedures for various types of printers. After reading “Preparing to Print” on the next page, follow the instructions applicable to your printer on the pages indicated.

“Bubble Jet Direct” is abbreviated as “BJ Direct.”

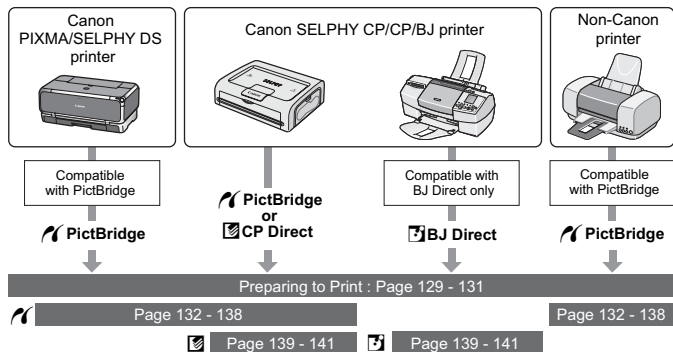

Preparing to Print

You do the direct printing procedure entirely with your camera while you look at the LCD monitor.

Connecting the Camera to the Printer

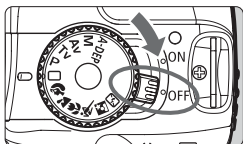





1 Set the camera's power switch to <OFF>.

2 Set up the printer.

- For details, refer to the printer's instruction manual.

3 Connect the camera to the printer.

- Refer to the table to see which cable you should use.

Printer		Applicable Cable
 PictBridge only	Interface cable provided with camera The plug at both ends have the <↔> icon.	
 PictBridge and CP Direct		
 PictBridge and BJ Direct		
 CP Direct only	Cable provided with printer Only one plug has the <↔> icon.	
 BJ Direct only		

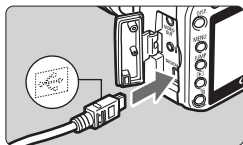

- When connecting the cable plug to the camera's <DIGITAL> terminal, the cable plug's <↔> icon must face the front side of the camera.
- To connect to the printer, refer to the printer's instruction manual.

4 Turn on the printer.

5 Set the camera's power switch to <ON>.

- ▶ Some printers may have a beeping sound.

6 Playback the image.

- Press the <▶> button.
- ▶ The image and the printer icon <🖨️>, <🖨️📄>, or <🖨️📄📄> indicating a printer connection will be displayed.
- ▶ The <🖨️📄📄> button lamp will light in blue.
- The procedure will be different depending on the icon displayed. See the applicable pages below.

🖨️ PictBridge



🖨️ CP Direct



🖨️ BJ Direct



Icon	Reference pages
	132 - 138, 143
	139 - 141, 143



- RAW images are not compatible with direct printing.
- If you use a battery to power the camera, make sure it is fully charged. With a fully charged battery, printing up to about 4 hours is possible.
- If there is a long beeping sound in step 5, it indicates a problem with the PictBridge printer. To find out what's wrong, do the following:
Press the <▶> button to playback the image and follow the steps below.
 1. Press <SET>.
 2. On the print setting screen, select **[Print]**.
The error message will be displayed on the LCD monitor. (p.138)
- When connecting the camera to the printer, do not use any cable other than the dedicated interface cable.
- After printing starts and while the <▶> button's blue lamp blinks, do not unplug the cable.
- Before disconnecting the cable, turn off the camera and printer first. Pull out the cable while holding the plug, not the cord.



For direct printing, using AC Adapter Kit ACK-DC20 (optional) to power the camera is recommended.

Printing with PictBridge

The setting options will differ depending on the printer. Some settings might be disabled. For details, refer to your printer's instruction manual.



1 Select the image to be printed.

- Check that the <Printer icon> is displayed on the upper left of the LCD monitor.
- Press the <Left/Right> key to select the image to be printed.

2 Press <SET>.

- ▶ The print setting screen will appear.

Print setting screen



Sets the printing effects.

Sets the date or file number imprinting to on or off.

Sets the quantity to be printed.

Sets the trimming area.

Sets the paper size, type, and layout.

Returns to step 1.

Starts the printing.

The paper size, type, and layout you have set will be displayed.

* Depending on the type of printer, the date and file number imprinting, trimming, and other settings might not be available.



3 Select [Paper settings].

- Select [Paper settings] and press <SET>.
- ▶ The Paper settings screen will appear.

Setting the Paper Size



- Select the size of the paper loaded in the printer, then press <SET>.
- ▶ The Paper type screen will appear.

Setting the Paper Type

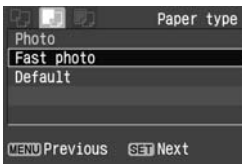

- Select the type of the paper loaded in the printer, then press <SET>.
- ▶ The Page layout screen will appear.



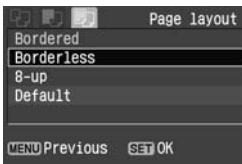

About the Paper Type

When using a Canon printer and Canon paper, read the printer's instruction manual to check what paper types can be used.

Setting the Page Layout



- Select Page layout, then press <SET>.
- ▶ The print setting screen will reappear.

Borderless	The print will have no white borders. If your printer cannot print borderless prints, the print will have borders.
Bordered	The print will have a white border along the edges.
Bordered 	The shooting information* will be imprinted on the border on 9x13cm and larger prints.
xx-up	Option to print 2, 4, 8, 9, 16, or 20 images on one sheet.
20-up  35-up 	On A4 / Letter size paper, 20 or 35 thumbnails of the images ordered through DPOF will be printed. [20-up ] will have the shooting information* printed on the side of each thumbnail and the file number and date** printed on the bottom of each thumbnail image. [35-up ] will have the file number and date** printed on the bottom of the thumbnail images.
Default	With a Canon printer, the print will be borderless.





* From the Exif data, the camera name, lens name, shooting mode, shutter speed, aperture, exposure compensation amount, ISO speed, white balance, etc., will be imprinted.

** This depends on the <📅> date/file number imprinting option set in step 5 (p.137).



4 Set the printing effects.

- Set as necessary. If you need not set any printing effects, go to step 5 on page 137.
- Select the desired item on the upper right, then press <SET>.
- Next, press the <◀▶> key to select the desired printing effect, then press <SET>.

 Off	Same as the printing characteristics turned “On”. No automatic correction will be performed.
 On	The image will be printed according to the printer’s standard color. The image’s Exif data is used to make automatic corrections.
 Vivid	The image will be printed with higher saturation to produce more vivid blues and greens.
B/W B/W	Prints black-and-white with true blacks.
B/W Cool tone	Prints in black-and-white with cool, bluish blacks.
B/W Warm tone	Prints in black-and-white with warm, yellowish blacks.
 Natural	No automatic correction will be performed, and the image’s natural color and contrast will be retained.
 Natural M	The printing characteristics are the same as the “Natural” setting. However, this setting enables finer printing adjustments than with “Natural.”

Depending on the printer, certain items might not be displayed.

Adjustment of Printing Effects

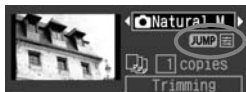

- With step 4, select the item. When **JUMP** is displayed as shown on the left, press the <JUMP> button. You can then set the parameters for fine adjustments.

The parameters that can be adjusted for the selected item are shown in the table below.

- Select the item, then press <SET>.

(○: Adjustable)

Item		Off / On / Vivid / Natural	Natural M	B/W / Cool tone / Warm tone
Brightness		○	○	○
Adjust levels		—	○	○
☺ (face) Brightener		○	○	○
Red-eye correction		○	○	○
Detail set.	Contrast	—	○	○
	Saturation		○	—
	Color tone		○	
	Color balance		○	

- After making fine adjustments for the printing effect, if you do step 4 again to change the printing effect's setting, the adjustments will all revert to the default.

- When **[Default]** is selected, the printing adjustments can not be adjusted.

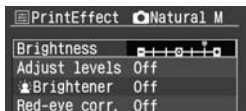

[Brightness]

- Press the <◀▶> key to make the adjustment, then press <SET>.

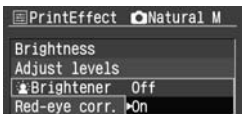
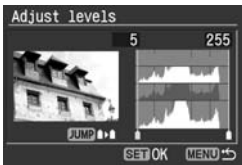
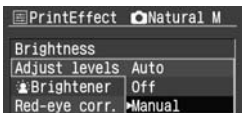

[Adjust levels]

- Select the item, then press <SET>.
- Select **[Manual]** and press <SET>. The Adjust levels screen will then appear.
- Press the <◀▶> key to adjust the shadows (black) within 0 to 127.
- Press the <JUMP> button.
- Press the <◀▶> key to adjust the highlights (white) within 128 to 255.
- Press <SET> to exit. The previous screen will reappear.

[Brightener] [Red-eye corr.]

- Select **[Off]** or **[On]**, then press <SET>.

Detail Settings of Printing Effects



- Select **[Detail set.]**, then press <SET>. The Detail set. screen will then appear.
- Select the item, then press <SET>.

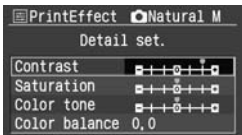

[Contrast] [Saturation] [Color tone]

- Press the <◀▶> key to make the adjustment, then press <SET>.

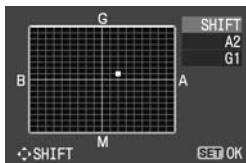
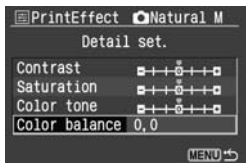

[Color balance]

- Press the <⬆> key in any of the four directions to move the “■” mark to the desired position.
- B is for blue, A is amber, M is magenta, and G is green. The color balance will shift in the respective direction.
- On the upper right, “SHIFT” indicates the color balance direction and correction amount.
- Press <SET> to exit. The previous screen will reappear.
- After completing the detail settings of printing effects, press the <MENU> button, then go to step 5.



5 Setting the date and file number imprinting.

- Set as necessary.
- Select <☺>.
- Press the <◀▶> key to select the item(s) to imprint.



6 Set the number of copies.

- Set as necessary.
- Select <☺>.
- Press the <◀▶> key to select the printing quantity.
- For details on trimming, see page 142.



7 Start printing.

- Select [**Print**], then press <SET>.
- ▶ The <Print> button's blue lamp will blink and the printing will start.
- When the printing ends, the screen will return to step 1.
- To stop the printing, press <SET> while [**Stop**] is displayed, then select [**OK**] and press <SET>.

Handling Printer Errors

If you resolve a printer error (no ink, no paper, etc.) and select [**Continue**] to resume printing but it does not resume, operate the buttons on the printer to resume printing. For details, see the printer's instruction manual.

Error Messages

If a problem occurs during printing, an error message will appear on the camera's LCD monitor. Press <SET> to stop printing. After resolving the problem, resume printing. For details on how to resolve a printing problem, refer to the printer's instruction manual.

Paper Error

Check whether the paper is properly loaded in the printer.

Ink Error

Check the printer's ink level, and check the waste ink tank.

Hardware Error

Check for any printer problems other than paper and ink problems.

File Error

The selected image cannot be printed via PictBridge. Images taken with a different camera or images edited with a computer might not be printable.





- Depending on the image's file size and recording quality, it may take some time for the printing to start after you select [**Print**].
- The [**Default**] setting for printing effects and other options are the printer's own default settings as set by the printer's manufacturer. See the printer's instruction manual to find out what the [**Default**] settings are.

Printing with CP Direct and BJ Direct ■

Printer-connected icon



1 Select the image to be printed.

- Check that the  or  icon is displayed on the upper left of the LCD monitor.
- Press the  key to select the image to be printed.

2 Press .

- ▶ The print setting screen will appear.

Print setting screen



— Sets the quantity to be printed.

— Sets the trimming area.

— Sets the printing style.

— Returns to step 1.

— Starts the printing.

The printing style settings are displayed.

 is the date icon.

3 Select [Style].

- Select [Style], then press .
- ▶ The Style screen will appear.



[Image] (CP Direct)



[Paper] (BJ Direct)

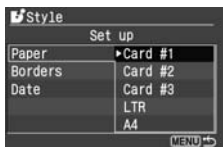

[Borders]



[Date]

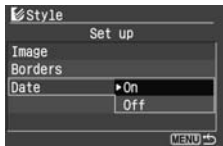

4 Set the options as desired.

- Select the item, then press <SET>.
- Select the setting, then press <SET>.
- [Image] (CP Direct) is selectable when card-size paper is used. If you select [Multiple], 8 small images of the same picture will be printed on the paper.
- For [Paper] (BJ Direct), select the size of the paper loaded in the printer.
- Check the [Borders] and [Date] settings and set them if necessary.
- When you are done, press the <MENU> button to return to the print setting screen.

5 Set the number of copies.

- Set as necessary.
- Select <[Copies]>.
- Press the <◀▶> key to set the number of copies, then press <SET>.
- Set a number from 1 to 99.



6 Set the trimming.

- Set as necessary.
- For details on trimming, see page 142.



7 Start printing.

- Select **[Print]**, then press **< (SET) >**.
- ▶ The **< (Print) >** button's blue lamp will blink and the printing will start.
- When the printing ends, the screen will return to step 1.
- To stop the printing, press **< (SET) >** while **[Stop]** is displayed, then select **[OK]** and press **< (SET) >**.



- With CP Direct, the date may look light if it is imprinted on a bright background or border.
- With CP Direct, if **[Multiple]** is selected, **[Borders]** and **[Date]** cannot be selected. **[Borderless]** will be set and **[Date]** will be set to **[Off]**. The image will also be cut off along all four edges.
- With BJ Direct, if **[Bordered]** is set, the date might be imprinted on the border, depending on the printer.



- With CP Direct, if you select **[Stop]** while printing only one picture, the printing will not stop. If you are printing multiple pictures, the printing will stop after the current picture is finished printing.
- If a problem occurs during printing, an error message will appear on the camera's LCD monitor.

Trimming the Image

You can trim the image and print only the trimmed portion as if the image was recomposed.

Do the trimming right before printing. If you set the trimming and then set the print settings, you may have to set the trimming again.



1 Select [Trimming].

- Select [Trimming], then press <SET>.
- ▶ The trimming screen will appear.



2 Trim the image.

- The image area within the trimming frame will be printed.
- The operation guide disappears while you trim the image. It will reappear after 5 sec. of idle time.



Changing the trimming frame size

- When you press the <Q> or <Q-Q> button, the size of the trimming frame will change. The smaller the trimming frame, the larger the image magnification will be.



Moving the trimming frame

- Press the <4> key to move the trimming frame in the respective direction. Move the trimming frame until it shows the desired image area or composition.

Rotating the frame

- The <DISP.> button toggles between the vertical and horizontal orientation of the trimming frame. For example, a horizontal shot can be printed as a vertical shot.

Image area to be printed



3 Exit the menu.

- Press <SET>.
- ▶ The Print setting screen will reappear.
- ▶ On the upper left, you can see the trimmed image area that will be printed.



- Depending on the printer, the trimmed image area might not be printed as you specified.
- The smaller you make the trimming frame, the grainier the picture will look. If the picture will be too grainy, the trimming frame will turn red.
- While trimming the image, look at the camera's LCD monitor. If you look at the image on a TV screen, the trimming frame might not be displayed accurately.



The trimming frame shape will be different depending on the [Paper settings], [Image] / [Paper], [Page layout] / [Borders] settings.

Easy Printing

When you print directly from your camera to your printer, the printing settings will be saved in your camera. To use the same settings again, follow the steps below.



- Select the image, then press the <Print> button lamp that lights in blue.
- The printing will start.



- Only one print can be printed each time.
- Any trimming will not be applied.

MENU Print Ordering

Print Settings

Set the print type, date imprinting, and file No. imprinting. The print settings will be applied to all print-ordered images. (They cannot be set individually for each image.)



1 Select [Print order].

- Under the [▶] tab, select [Print order], then press <SET>.
- ▶ The Print order screen will appear.

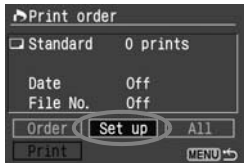

2 Select [Set up].

- Press the <◀▶> key to select [Set up], then press <SET>.
- ▶ The print setting screen will appear.

3 Set the options as desired.

- Set the [Print type], [Date], and [File No.].
- Select the item, then press <SET>.
- Select the setting, then press <SET>.

[Print type]

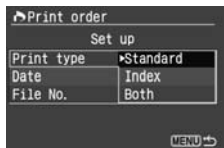



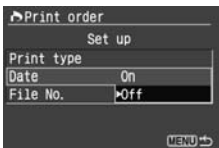

[Date]

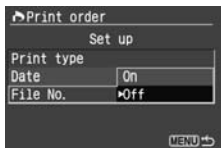

[File No.]



Print type		Standard	Prints one image on one sheet.
		Index	Multiple, thumbnail images are printed on one sheet.
	 	Both	Prints both the standard and index prints.
Date	On	[On] imprints the recorded date on the print.	
	Off		
File No.	On	[On] imprints the file No. on the print.	
	Off		

4 Exit the menu.

- Press the <MENU> button.
- ▶ The Print order screen will reappear.

- Next, select [**Order**] or [**All**] to select the images to be printed.



- RAW images cannot be selected for printing.
- Even if [**Date**] and [**File No.**] are set to [**On**], the date or file No. might not be imprinted depending on the print type setting and printer model.
- With [**Index**] prints, both the [**Date**] and [**File No.**] cannot be set to [**On**] at the same time.
- When printing with DPOF, you must use the CF card whose print order specifications have been set. It will not work if you just extract images from the CF card and try to print them.
- Certain DPOF-compatible printers and photofinisher might not be able to print the photos as you specified. If this happens with your printer, refer to the printer's instruction manual. Or check with your photofinisher about compatibility when ordering prints.
- Do not insert into the camera a CF card whose print order were set by a different camera and then try to specify a print order. The print order may not work or may be overwritten. Also, depending on the image type, the print order may not be possible.

Selecting Individual Images

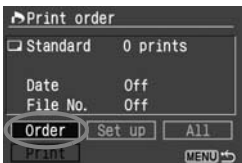

1 Select [Order].

- Press the <◀▶> key to select [Order], then press <SET>.
- ▶ The order screen will appear.



2 Select the image to be printed.

- Press the <◀▶> key to select the image to be printed.
- Press the <☒-Q> button to display the three-image view. To return to the single-image display, press the <Q> button.

Three-image display



3 Order the print.

- The print order will vary depending on the [Print type] (p.144) setting.

For [Standard] and [Both]

- For standard-type prints, you can set the quantity (up to 99) for each image.
- Press the <▲▼> key to select the print quantity.

[Standard]



[Both]



Quantity

Total

Index icon

[Index]

Check mark

Index icon

For [Index]

- If you want to include the image in the index print, checkmark the box <✓>. To deselect it, leave the box unchecked.
- Pressing the <▲▼> key toggles between checkmarking and uncheckmarking the box.
- To select other images, repeat steps 2 and 3.
- You can select up to 998 images.

4 Exit the menu.

- Press the <MENU> button.
- ▶ The Print order screen will reappear.
- Press the <MENU> button again to save the print order to the CF card. The menu will then reappear.

Selecting All Images

The print order can also be set or canceled for all the images in the CF card. For standard-type prints, a quantity of one will be ordered for all the images.

Note that after following the “Selecting Individual Images” procedure, if you do the “Selecting All Images” procedure, the print order will change to “All images.”

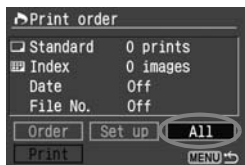

1 Select [All].

- Press the <◀▶> key to select [All], then press <SET>.
- ▶ The All screen will appear.

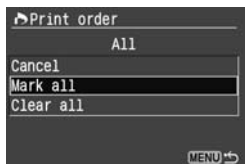

2 Select [Mark all].

- Select [Mark all], then press <SET>.
- ▶ One print each will be specified for all the images, then the Print order screen will reappear.
- If you select [Clear all], all the images selected for printing will be deselected.

3 Exit the menu.

- On the Print order screen, press the <MENU> button.
- ▶ The image selections will be saved to the CF card, and the menu will reappear.

- Note that RAW images cannot be selected for printing even when you set “Mark all.”
- When using a PictBridge printer, print no more than 400 images for one print order. If you specify more than this, all the selected images might not be printed.

MENU Direct Printing with DPOF

With a printer compatible with direct printing, you can easily print images specified with DPOF.

1 Prepare to print.

- See page 129, 130.
“Connecting the Camera to the Printer” up to step 5.

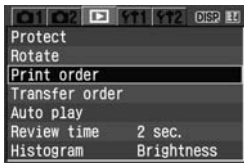

2 Select [Print order].

- Under the [▶] tab, select **[Print order]**, then press <SET>.
- ▶ The Print order screen will appear.

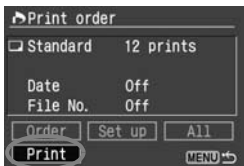

3 Select [Print].

- Press the <⬅> key to select **[Print]**, then press <SET>.
- **[Print]** will be displayed only if the camera is connected to the printer and printing is possible.
- ▶ The print setting screen will appear.

4 Set the printing options.

PictBridge

CP Direct

BJ Direct

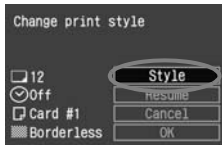
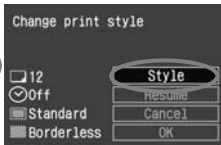
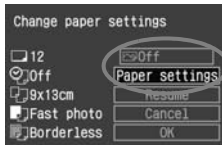



PictBridge

- Set the **[Paper settings]** and if necessary, also set the printing effects. (p.132, 134)

 **CP Direct /  BJ Direct**

- Set the **[Style]**. (p.139)

5 Start printing.

- Select **[OK]**, then press <>.
- ▶ The printing will start.
- To stop the printing, press <> while **[Stop]** is displayed, then select **[OK]** and press <>.

- When printing with PictBridge or BJ Direct, be sure to set the paper size.
- With PictBridge, some printers cannot imprint the file No.
- If **[Bordered]** is set, the date might be imprinted on the border, depending on the printer.
- The date might look light if it is imprinted on a bright background or border.
- Under **[Adjust levels]**, **[Manual]** (p.136) cannot be selected.

- With CP Direct, if **[Print type]** is set to **[Index]**, the number of images printed on one index sheet will be as follows:
 - Credit card size: 20 images
 - 9 x 13 cm size: 42 images
 - 10 x 14.8 cm size: 63 images
 As for the number of index images with BJ Direct, see the BJ printer's instruction manual.
- If you stopped the printing and want to resume printing the remaining images, select **[Resume]**. Note that printing will not resume if you stop the printing and any of the following occurs:
 - Before resuming the printing, you changed the print order settings.
 - Before resuming the printing, you erased an image that was to be printed.
 - In the case of index printing with CP Direct, you changed the paper cassette before resuming the printing.
 - In the case of index printing with PictBridge, you changed the paper settings before resuming the printing.
 - When you stopped the printing, the CF card's remaining capacity was low.
- If a problem occurs during printing, see page 138 for PictBridge, page 141 for CP Direct, and page 141 for BJ Direct.

8

Reference

This chapter provides reference information for camera features, system accessories, and other things. The back of this chapter also has an index to make it easier to look up things.

External Speedlites

EOS-dedicated, EX-series Speedlites

Basically operates like a built-in flash for easy operation.

When an EX-series Speedlite is attached to the camera, almost all the autoflash control is done by the camera. In other words, it is like a high-output flash attached externally in place of the built-in flash. For detailed procedures, see the EX-series Speedlite's instruction manual. The camera is a Type-A camera compatible with all features of EX-series Speedlites.

Shoe-mount Speedlites



Macro Lites



Canon Speedlites other than the EX-series

The flash cannot be fired with an EZ/E/EG/ML/TL-series Speedlite set in the TTL or A-TTL autoflash mode. Use the Speedlite's manual flash mode instead if provided.

Non-Canon Speedlites

The camera can synchronize with compact, non-Canon flash units at 1/200 sec. or slower. Be sure to test the flash unit beforehand to make sure it synchronizes properly with the camera.

- If the camera is used with a flash unit or flash accessory dedicated to another camera brand, the camera may not operate properly and malfunction may result.
- Do not attach a high-voltage flash unit on the camera's hot shoe. It might not work.

Wireless Remote Control

With Remote Controller RC-1 or RC-5 (optional), you can shoot remotely up to about 5 meters/16.4 feet directly in front of the camera. Use the self-timer to do steps 1 and 2 on page 49.

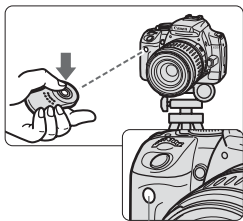

Remote control sensor

Take the picture.

- Point the remote controller toward the camera's remote control sensor and press the transmit button.
- ▶ The camera will autofocus.
- ▶ When focus is achieved, the self-timer lamp will light and the picture will be taken.

⚠ Camera misoperation may occur near certain types of fluorescent light. During wireless remote control, try to keep the camera away from fluorescent light.

Using the Eyepiece Cover

If you take a picture without looking at the viewfinder, light entering the eyepiece can throw off the exposure. To prevent this, use the eyepiece cover attached to the camera strap.

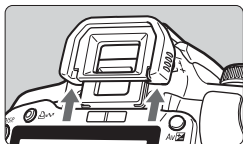

1 Remove the eyecup.

- From the bottom of the eyecup, push it upward.

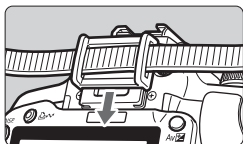

2 Attaching the Eyepiece Cover.

- Slide the eyepiece cover down into the eyepiece groove to attach it.

Using a Household Power Outlet

With AC Adapter Kit ACK-DC20 (optional), you can connect the camera to a household power outlet and not worry about the battery level.

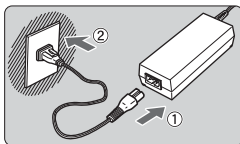

1 Connect the power cord.

- Connect the power cord as shown in the illustration.
- When you are finished, disconnect the plug from the power outlet.

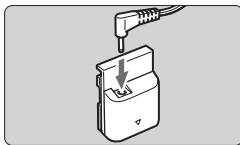

2 Connect the DC Coupler DR-700.

- Connect the cord's plug to the DC Coupler DR-700.
- DC Coupler DR-20 is cannot be used with this camera.

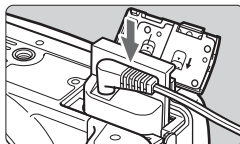

3 Insert the DC Coupler.

- Open the cover and insert the DC Coupler until it locks in place.

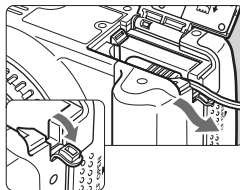

4 Push in the DC cord.

- Open the DC cord cover and install the cord as shown.
- Close the cover.

! Do not connect or disconnect the power cord while the camera's power switch is set to <ON>.

Replacing the Date/Time Battery

The date/time (back-up) battery maintains the camera's date and time. Its service life is about 5 years. If the battery is replaced and the date/time dialog appears, replace the lithium CR2016 battery with a new one.

The date/time setting will also be reset, so be sure to set the correct date/time.

1 Set the power switch to <OFF>.

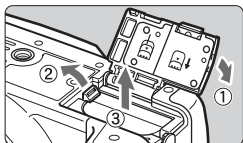

2 Open the cover and remove the battery.

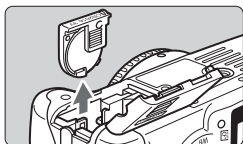

3 Take off the battery holder.

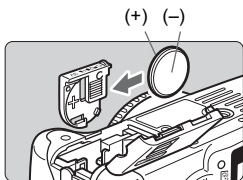

4 Replace the battery.

- Make sure the battery is in the proper + - orientation.

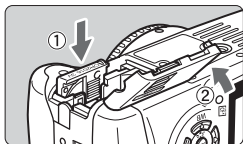

5 Insert the battery holder and close the cover.

 For the date/time battery, be sure to use a CR2016 lithium battery.

Menu Settings

< 1 > Shooting 1 menu (Red)

Reference
pages

Quality	L / L / M / M / S / S / RAW+ L / RAW	60
Red-eye On/Off	Off / On	55
Beep	On / Off	94
Shoot w/o card	On / Off	94

< 2 > Shooting 2 menu (Red)

AEB	1/3-stop increments, ± 2 stops	76
Flash exp comp	1/3-stop increments, ± 2 stops	75
WB SHIFT/BKT	WB correction: B/A/M/G bias, 9 levels each	88
	WB-BKT: B/A and M/G bias 1 level, ± 3 levels	89
Custom WB	Manual setting of white balance	86
Color space	sRGB / Adobe RGB	83
Picture Style	Standard / Portrait / Landscape /	63
	Neutral / Faithful / Monochrome	78
	User Def. 1-3	81
Dust Delete Data	Obtaining data to eliminate dust spots with bundled software	112

< > Playback menu (Blue)

Protect	Erase-protect image	122
Rotate	Rotate vertical image	119
Print order	Specifies images to be printed (DPOF)	144
		149
Transfer order	Select images to be transferred to a personal computer	107
Auto play	Auto playback of images	120
Review time	Off / 2 sec. / 4 sec. / 8 sec. / Hold	94
Histogram	Brightness / RGB	125



- < 2 > Shooting 2 menu screen/tabs are not displayed in Basic Zone modes.
- Shaded menu items are not displayed in Basic Zone modes.
- In Basic Zone modes, the RAW+ L and RAW recording quality modes are not displayed.

<F1> Set-up 1 menu (Yellow)

Reference
pages

Auto power off	30 sec. / 1min. / 2 min. / 4 min. / 8 min. / 15 min. / Off	95
Auto rotate	On / On / Off	98
LCD brightness	LCD monitor brightness adjustment	95
LCD auto off	Enabled / Disabled	101
Date/Time	Setting the Date/Time	37
File numbering	Continuous / Auto reset / Manual reset	96
Format	Initialize and erase data in the CF card	38

<F2> Set-up 2 menu (Yellow)

Language	15 languages (English, German, French, Dutch, Danish, Finnish, Italian, Norwegian, Swedish, Spanish, Russian, Simplified Chinese, Traditional Chinese, Korean, and Japanese.)	37
Video system	NTSC / PAL	121
Custom Functions (C.Fn)	Customize the camera	101
Clear settings	Clear all camera settings (Resets the camera to the default settings.) Clear all Custom Functions (Resets all Custom Function settings to the default.)	100
Sensor cleaning : Auto	Clean now / Clean when the power switch is turned <ON> or <OFF> (Enable / Disable).	111
Sensor cleaning : Manual	Clean manually from the lens mount	114
Firmware Ver.	Select to update the firmware	-

Function Availability Table

●: Set automatically ○: User selectable □: Not selectable

Mode Dial		Basic Zone						Creative Zone						
									P	Tv	Av	M	A-DEP	
Quality	JPEG	○	○	○	○	○	○	○	○	○	○	○	○	
	RAW								○	○	○	○	○	
	RAW + JPEG								○	○	○	○	○	
ISO speed	Auto	●	●	●	●	●	●							
	Manual								○	○	○	○	○	
Picture Style	Standard	●			●	●	●		○	○	○	○	○	
	Portrait		●						○	○	○	○	○	
	Landscape			●					○	○	○	○	○	
	Neutral								○	○	○	○	○	
	Faithful								○	○	○	○	○	
	Monochrome								○	○	○	○	○	
	User Defined								○	○	○	○	○	
White balance	Auto WB	●	●	●	●	●	●		○	○	○	○	○	
	Preset WB								○	○	○	○	○	
	Custom WB								○	○	○	○	○	
	WB correction								○	○	○	○	○	
	WB bracketing								○	○	○	○	○	
AF	One-Shot		●	●	●		●		○	○	○	○	●	
	AI Servo					●			○	○	○	○		
	AI Focus	●						●	○	○	○	○		
	AF point selection	Auto	●	●	●	●	●	●		○	○	○	○	●
		Manual								○	○	○	○	
AF-assist beam	●	●		●		●		○	○	○	○	○		
Drive	Single	●		●	●		●		○	○	○	○	○	
	Continuous		●			●			○	○	○	○	○	
	Self-timer	○	○	○	○	○	○		○	○	○	○	○	

Mode Dial		Basic Zone						Creative Zone				
								P	Tv	Av	M	A-DEP
Metering mode	Evaluative	●	●	●	●	●	●	○	○	○	○	○
	Partial							○	○	○	○	○
	Center-weighted average							○	○	○	○	○
Exposure	Program shift							○				
	Exposure compensation							○	○	○		○
	AEB							○	○	○	○	○
	AE lock							○	○	○		○
	Depth-of-field preview							○	○	○	○	○
Built-in flash	Auto	●	●		●		●					
	Manual							○	○	○	○	○
	Flash off			●		●		●				
	Red-eye reduction	○	○		○		○		○	○	○	○
	FE lock							○	○	○	○	○
	Flash exposure compensation							○	○	○	○	○
Color space	sRGB	●	●	●	●	●	●	○	○	○	○	○
	Adobe RGB							○	○	○	○	○

AE Lock

(In Creative Zone modes)

Metering mode	AF point selection	
	Automatic AF point selection	Manual AF point selection
Evaluative metering*	AE lock is applied at the AF point that achieved focus.	AE lock is applied at the selected AF point.
Partial metering	AE lock is applied at the center AF point.	
Center-weighted average metering		

* When the lens' focus mode switch is set to <MF>, AE lock is applied at the center AF point.

When Autofocus Fails

The camera might not be able to focus the following types of subjects:

- Low-contrast subjects
Example: Blue sky, solid-color walls, etc.
- Subjects in low light.
- Extremely backlit reflective subjects
Example: Car with a reflective body, etc.
- Overlapping near and far objects
Example: Animal in a cage, etc.
- Repetitive patterns
Example: Skyscraper windows, computer keyboards, etc.

In such cases, do one of the following:

1. Focus an object at the same distance as the subject and lock the focus before recomposing. (p.42)
2. Set the lens focus mode switch to **<MF>** and focus manually.



If an Extender (optional) is attached and the maximum aperture of the lens is f/5.6 or smaller (larger f/number), AF will not be possible. For details, see the Extender's instruction manual.

Shooting

No images can be shot or recorded.

- The CF card is not properly inserted. (p.28)
- If the CF card is full, replace with a new CF card or erase unnecessary images. (p.28, 123)
- If you try to focus in the One-Shot AF mode while the focus confirmation light <●> in the viewfinder blinks, a picture cannot be taken. Press the shutter button halfway again to focus, or focus manually. (p.33, 58)

The LCD monitor does not display a clear image.

- If dust is adhering to the LCD monitor, wipe with a lens cloth or soft cloth.
- In low or high temperatures, the LCD monitor display may seem slow or it might look black. It will return to normal at room temperature.

The image is out of focus.

- Set the lens focus mode switch to <AF>. (p.30)
- To prevent camera shake, hold the camera still and press the shutter button gently. (p.32, 33)

The CF card cannot be used.

- If a CF card-related error message is displayed, see page 38 or 163.

The camera makes a noise when it is shaken.

- The built-in flash's pop-up mechanism shakes slightly. This is normal.

Image Review & Operation

The image cannot be erased.

- If the image has been erase-protected, it cannot be erased. (p.122)

The wrong shooting date and time is displayed.

- The correct date and time has not been set. (p.37)

No image appears on the TV screen.

- Make sure the video cable plug is connected all the way in. (p.121)
- Set the video OUT format (NTSC/PAL) to the same video format as the TV. (p.157)
- Use the video cable that came with the camera. (p.121)

Error Codes

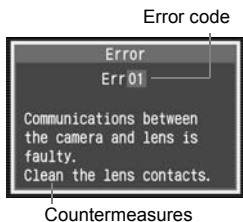

If a problem occurs with the camera, an error message is displayed. Follow the suggested solution to resolve the problem. To recover from the error screen, turn the power switch off and on, or remove and reinstall the battery. If error 02 (CF card problem) is displayed, remove and reinstall the CF card or format the card. This may resolve the problem.

If the same error keeps occurring, there may be a problem. Write down the error code and consult your nearest Canon Service Center.

- If an error code appears right after shooting, the picture might not have been captured. After the error is resolved, press the <▶> button and check if the picture was captured.

System Map

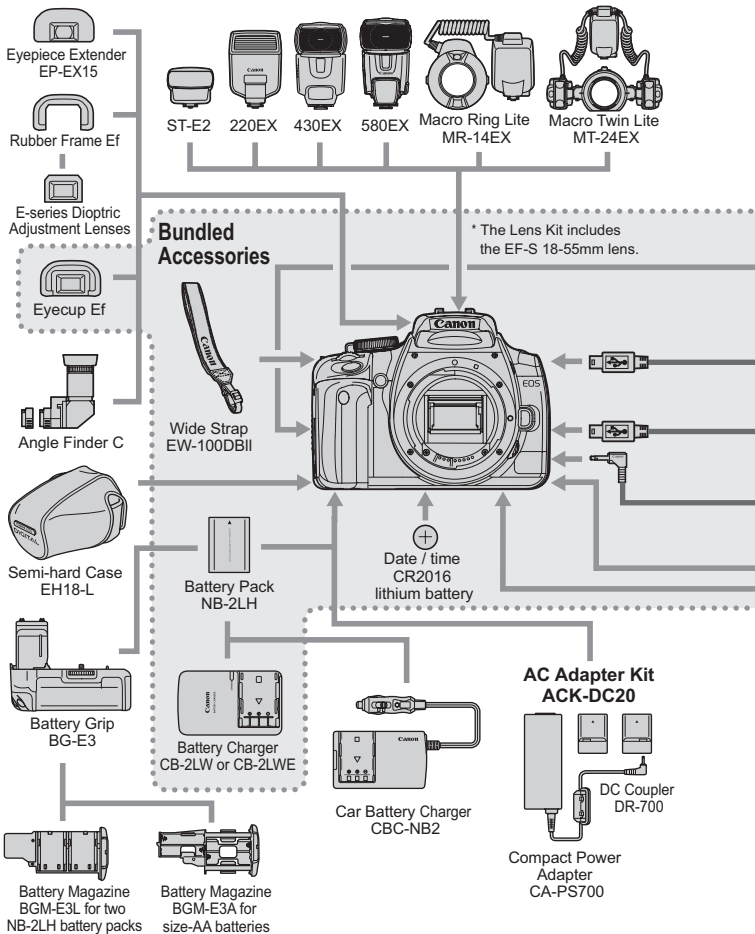

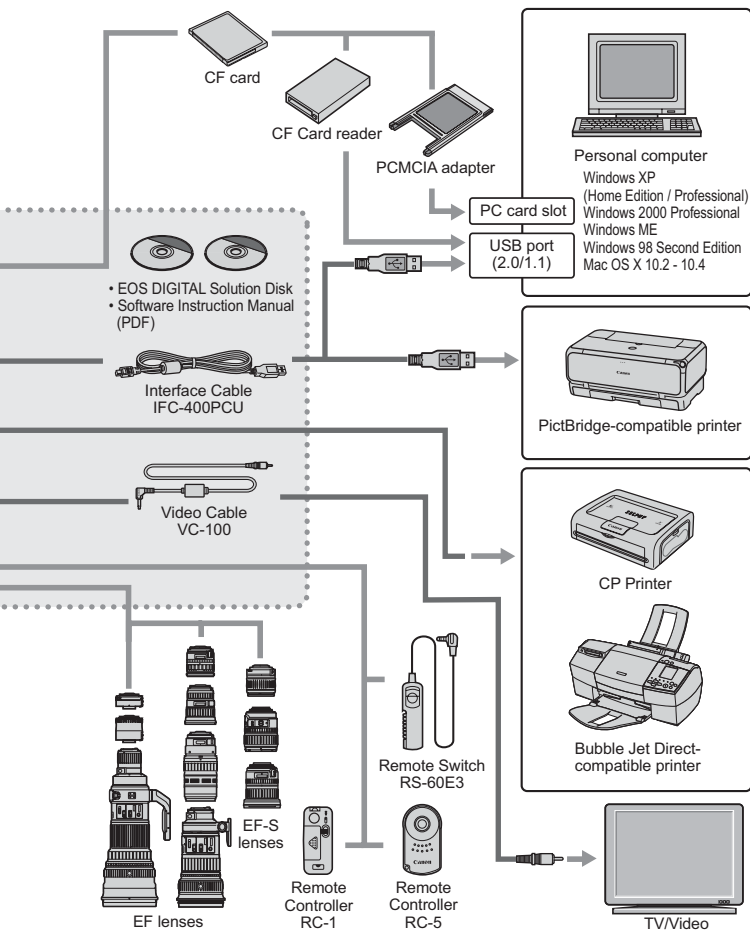

Specifications

• Type

Type:	Digital, single-lens reflex, AF/AE camera with built-in flash
Recording media:	Type I or II CF card * Compatible with Microdrive and 2GB or larger CF cards
Image sensor size:	22.2 x 14.8mm
Compatible lenses:	Canon EF lenses (including EF-S lenses) (35mm-equivalent focal length is approx. 1.6 times the lens focal length)
Lens mount:	Canon EF mount

• Imaging Element

Type:	High-sensitivity, high-resolution, large single-plate CMOS sensor
Pixels:	Effective pixels: Approx. 10.10 megapixels Total pixels: Approx. 10.50 megapixels
Aspect ratio:	3:2
Color filter system:	RGB primary color filter
Low-pass filter:	Located in front of the image sensor, non-removable
Dust deletion feature:	(1) Sensor cleaning: Auto (2) Sensor cleaning: Manual (3) Dust Delete Data appended to image data

• Recording System

Recording format:	Design rule for Camera File System 2.0
Image type:	JPEG, RAW (12bit)
RAW+JPEG	
simultaneous recording:	Provided
File size:	(1) Large/Fine: Approx. 3.8MB (3888 x 2592 pixels) (2) Large/Normal: Approx. 2.0MB (3888 x 2592 pixels) (3) Medium/Fine: Approx. 2.3MB (2816 x 1880 pixels) (4) Medium/Normal: Approx. 1.2MB (2816 x 1880 pixels) (5) Small/Fine: Approx. 1.3MB (1936 x 1288 pixels) (6) Small/Normal: Approx. 0.7MB (1936 x 1288 pixels) (7) RAW: Approx. 9.8MB (3888 x 2592 pixels) * Exact file sizes depend on the subject, ISO speed, Picture Style, etc.
File numbering:	Consecutive numbering, auto reset, manual reset
Color space:	sRGB, Adobe RGB
Picture Style:	Standard, Portrait, Landscape, Neutral, Faithful, Monochrome, User Def. 1 - 3
Interface:	USB port (USB 2.0 Hi-Speed): For connection to a personal computer and direct printing Video OUT terminal (NTSC/PAL)

• White Balance

Type:	Auto, daylight, shade, cloudy, tungsten, white fluorescent light, flash, custom
Auto white balance:	Auto white balance with the image sensor
Color temperature compensation:	White balance correction: ± 9 stops in full-stop increments White balance bracketing: ± 3 stops in full-stop increments * Blue/amber bias or magenta/green bias possible
Color temperature information transmission:	Provided

• Viewfinder

Type:	Eye-level pentamirror
Coverage:	Vertical/Horizontal approx. 95%
Magnification:	Approx. 0.8x (-1 diopter with 50mm lens at infinity)
Eyepoint:	Approx. 20 mm
Built-in dioptic adjustment:	-3.0 - +1.0 diopter
Focusing screen:	Fixed, precision matte
Mirror:	Quick-return half mirror (Transmission:reflection ratio of 40:60, no mirror cut-off with EF600mm f/4L IS USM or shorter lenses)
Viewfinder information:	AF information (AF points, focus confirmation light), exposure information (shutter speed, aperture, AE lock, exposure level, exposure warning), flash information (flash ready, high-speed sync, FE lock, flash exposure compensation), white balance correction, maximum burst, CF card information
Depth-of-field preview:	Enabled with depth-of-field preview button

• Autofocus

Type:	TTL secondary image-registration, phase detection
AF points:	9 AF points
Metering range:	EV -0.5 - 18 (at 23°C/73°F, ISO 100)
Focus modes:	One-Shot AF, AI Servo AF, AI Focus AF, Manual focusing (MF)
AF point selection:	Auto, manual
Selected AF point display:	Superimposed in viewfinder and indicated on LCD monitor
AF-assist beam:	Small series of flashes fired by built-in flash Effective range: Approx. 4.0m/13.1ft. at center, approx. 3.5m/11.5ft. at periphery

• Exposure Control

Metering modes:	35-zone TTL full aperture metering <ul style="list-style-type: none">· Evaluative metering (linkable to any AF point)· Partial metering (approx. 9% of viewfinder at center)· Center-weighted average metering
Metering range:	EV 1 - 20 (at 23°C/73°F with EF50mm f/1.4 USM lens, ISO 100)
Exposure control:	Program AE (Full Auto, Portrait, Landscape, Close-up, Sports, Night Portrait, Flash Off, Program), shutter-priority AE, aperture-priority AE, depth-of-field AE, manual exposure, E-TTL II autoflash
ISO speed:	Basic Zone modes: ISO 100 - 400 set automatically Creative Zone modes: Equivalent to ISO 100 - 1600 (in 1-stop increments)
Exposure compensation:	Manual: ± 2 stops in 1/3- or 1/2-stop increments (can be combined with AEB) AEB: ± 2 stops in 1/3- or 1/2-stop increments
AE lock:	Auto: Applied in One-Shot AF mode with evaluative metering when focus is achieved Manual: By AE lock button in all metering modes

• Shutter

Type:	Electronically-controlled, focal-plane shutter
Shutter speeds:	1/4000 to 30 sec. (1/3- and 1/2-stop increments), bulb, X-sync at 1/200 sec.
Shutter release:	Soft-touch electromagnetic release
Self-timer:	10-sec. delay
Remote control:	Remote Switch RS-60E3 Remote Controller RC-5/RC-1

• Built-in Flash

Type:	Retractable, auto pop-up flash
Flash metering:	E-TTL II autoflash
Guide No.:	13/43 (ISO 100, in meters/feet)
Recycle time:	Approx. 3 sec.
Flash-ready indicator:	Flash-ready icon lights in viewfinder
Flash coverage:	17mm lens angle of view
FE lock:	Provided
Flash exposure compensation:	± 2 stops in 1/3- or 1/2-stop increments

• External Speedlite

EOS-dedicated Speedlite:	E-TTL II autoflash with EX-series Speedlite
Zooming to match lens focal length:	Provided

• Drive System

Drive modes:	Single, continuous, and self-timer
Continuous shooting speed:	Max. 3 shots per sec.
Maximum burst:	JPEG (Large/Fine): Approx. 27, RAW: Approx. 10, RAW+JPEG (Large/Fine): Approx. 8
	* Based on Canon's testing conditions with a 512MB CF card
	* Varies depending on the subject, ISO speed, Picture Style, etc.

• LCD Monitor

Type:	TFT color liquid-crystal monitor
Monitor size:	2.5 in.
Pixels:	Approx. 230,000
Coverage:	Approx. 100%
Brightness adjustment:	7 levels provided
Interface languages:	15

• Image Playback

Display format:	Single image, shooting information, 9-image index, magnified view (approx. 1.5x - 10x), autoplay, image rotation, and jump (by 10 or 100 images, by date)
Highlight warning:	In the shooting information mode, any overexposed highlight areas with no image information will blink
Histogram:	Brightness, RGB

• Image Protection and Erase

Protect:	Single images can be erase-protected or not
Erase:	One image or all images in the CF card can be erased (except protected images)

• Direct Printing

Compatible printers:	PictBridge, CP Direct, and Bubble Jet Direct-compatible printers
Printable images:	JPEG images (DPOF printing possible)
Easy printing feature:	Provided

• DPOF: Digital Print Order Format

DPOF:	Version 1.1 compatible
-------	------------------------

• Direct Image Transfer

Compatible images: JPEG and RAW images
 * Images to be used for wallpaper on the personal computer screen must be JPEG images

• Customization

Custom Functions: 11 Custom Functions with 29 settings

• Power Source

Battery: Battery Pack NB-2LH, quantity 1
 * AC power enabled with AC Adapter ACK-DC20
 * With Battery Grip BG-E3, size-AA batteries can be used
 Battery life: [Number of shots · approx.]

Temperature	Shooting Conditions	
	No Flash	50% Flash Use
At 23°C / 73°F	500	360
At 0°C / 32°F	370	280

* The above figures apply when a fully-charged Battery Pack NB-2LH is used

* The figures above are based on CIPA (Camera & Imaging Products Association) testing standards

Battery check: Auto
 Power saving: Provided
 Power turns off after 30 sec., 1, 2, 4, 8, or 15 min.
 Date/Time battery: One CR2016 lithium battery
 Startup time: Approx. 0.2 sec.

• Dimensions and Weight

Dimensions (W x H x D): 126.5 x 94.2 x 65 mm / 5.0 x 3.7 x 2.6 in.

Weight: Approx. 510 g / 18.0 oz. (body only)

• Operation Environment

Working temperature range: 0°C - 40°C / 32°F - 104°F

Working humidity: 85% or less

• Battery Pack NB-2LH

Type: Rechargeable lithium ion battery
 Rated voltage: 7.4 V DC
 Battery capacity: 720 mAh
 Dimensions (W x H x D): 33.3 x 16.2 x 45.2 mm / 1.3 x 0.6 x 1.8 in.
 Weight: Approx. 43 g / 1.5 oz.

• Battery Charger CB-2LW

Compatible battery:	Battery Pack NB-2LH
Recharging time:	Approx. 90 min.
Rated input:	100 - 240 V AC, 50/60 Hz
Rated output:	8.4 V DC
Working temperature range:	0°C - 40°C / 32°F - 104°F
Working humidity:	85% or less
Dimensions (W x H x D):	91 x 56 x 22.5 mm / 3.6 x 2.2 x 0.9 in.
Weight:	Approx. 68 g / 2.4 oz.

• Battery Charger CB-2LWE

Compatible battery:	Battery Pack NB-2LH
Recharging time:	Approx. 90 min.
Rated input:	100 - 240 V AC, 50/60 Hz
Rated output:	8.4 V DC
Working temperature range:	0°C - 40°C / 32°F - 104°F
Working humidity:	85% or less
Dimensions (W x H x D):	91 x 56 x 22.5 mm / 3.6 x 2.2 x 0.9 in.
Weight:	Approx. 61 g / 2.2 oz. (without power cord)

• EF-S18-55mm f/3.5-5.6 II

Angle of view:	Diagonal extent: 74°20' - 27°50' Horizontal extent: 64°30' - 23°20' Vertical extent: 45°30' - 15°40'
Lens construction:	11 elements in 9 groups
Minimum aperture:	f/22 - 36
Closest focusing distance:	0.28 m / 0.92 ft.
Maximum magnification and field of view:	18mm: 0.10x (248 x 161 mm / 9.8 x 6.3 in.) 55mm: 0.28x (81 x 54 mm / 3.2 x 2.1 in.)
Filter size:	58mm
Hood:	EW-60C
Diameter x length:	68.5 x 66 mm / 2.7 x 2.6 in.
Weight:	Approx. 190 g / 6.7 oz.
Case:	LP814

- All the specifications above are based on Canon's testing standards.
- The camera's specifications and exterior are subject to change without notice.
- If a problem occurs with a non-Canon lens attached to the camera, consult the lens maker.



Image Conversion Factor

Since the image area is smaller than the 35mm film format, the equivalent lens focal length (crop factor) will increase by 1.6x.



Image size
22.2 x 14.8mm (0.87 x 0.58 in.)

35mm image size
36 x 24mm (1.42 x 0.94 in.)



U.S.A. and Canada only:

The Lithium ion/polymer battery that powers the product is recyclable. Please call 1-800-8-BATTERY for information on how to recycle this battery.

Digital Camera Model DS126151 Systems

This device complies with Part 15 of the FCC Rules. Operation is subject to the following two conditions: (1) This device may not cause harmful interference, and (2) this device must accept any interference received, including interference that may cause undesired operation.

Note: This equipment has been tested and found to comply with the limits for class B digital devices, pursuant to Part 15 of the FCC Rules.

These limits are designed to provide reasonable protection against harmful interference in a residential installation. This equipment generates, uses and can radiate radio frequency energy and, if not installed and used in accordance with the instructions, may cause harmful interference to radio communications. However, there is no guarantee that interference will not occur in a particular installation. If this equipment does cause harmful interference to radio or television reception, which can be determined by turning the equipment off and on, the user is encouraged to try to correct the interference by one or more of the following measures:

- Reorient or relocate the receiving antenna.
- Increase the separation between the equipment and receiver.
- Connect the equipment into an outlet on a circuit different from that to which the receiver is connected.
- Consult the dealer or an experienced radio/TV technician for help.

The cable with the ferrite core provided with the digital camera must be used with this equipment in order to comply with Class B limits in Subpart B of Part 15 of the FCC rules.

Do not make any changes or modifications to the equipment unless otherwise specified in the manual. If such changes or modifications should be made, you could be required to stop operation of the equipment.

Canon U.S.A. Inc.
One Canon Plaza, Lake Success, NY 11042, U.S.A.
Tel No. (516)328-5600

Index

- A**
- AC Adapter Kit 154
 - Access lamp 29
 - A-DEP
(Automatic depth-of-field AE)..... 72
 - Adobe RGB..... 83
 - AE lock..... 84
 - AEB (Auto Exposure Bracketing).... 76
 - AF → Focusing
 - AI Focus AF 56
 - Aperture-priority AE 68
 - Auto play (playback) 120
 - Auto playback 120
 - Auto power off..... 95
 - Auto rotate of vertical images 98
 - Autofocus → Focusing
 - Av (Aperture-priority AE)..... 68
- B**
- B/W (printing)..... 134
 - Basic Zone 20
 - Battery → Power
 - Battery check 26
 - Beeper 94
 - Black-and-white photo 64, 80
 - Bulb exposures 71
 - Noise reduction 103
- C**
- Camera
 - Camera Function Setting Display 99
 - Camera shake 90
 - Holding the camera 32
 - Reset to default settings..... 100
 - Camera shake 32, 33
 - Center-weighted average metering ... 73
 - CF card 13, 28, 38
 - CF card reminder 94
 - Format 38
 - Problem 38
 - Clear settings 100, 102
 - Clock → Date/Time
 - Close-up 45
 - Color balance (printing)..... 137
 - Color space 83
 - sRGB / Adobe RGB
 - Color tone..... 79, 135
 - Continuous shooting 59
 - Contrast..... 79, 135
 - Cool tone (printing)..... 134
 - Creative Zone..... 20
 - ★ icon 4
 - Custom Functions 101
 - C.Fn-1 102
 - C.Fn-2 103
 - C.Fn-3, 4, 5 104
 - C.Fn-6, 7, 8 105
 - C.Fn-9, 10, 11 106
 - Clearing all 100, 102
- D**
- Date → Date/Time
 - Date/Time 37
 - Date/time battery replacement.... 155
 - Depth-of-field preview 70
 - Dioptic adjustment 31
 - Direct printing → Printing
 - Display-off sensor 17, 34, 101
 - Drive mode 59
 - Single/Continuous shooting
 - Self-timer 49, 91
 - Dust Delete Data 112

E

Easy Printing	143
Erase (image)	123
Error codes	163
Evaluative metering	73
Exposure compensation	74
1/2-stop increments	105
External Speedlite	152
Eyepiece cover	22, 153

F

Face brightener (printing).....	135
Faithful	64
FE lock	85
File number	96
Continuous / Auto reset /	
Manual reset	
File size	166
Filter effect (Monochrome).....	80
Yellow / Orange / Red / Green	
Flash	
2nd-curtain sync	106
Effective range.....	54
External Speedlite.....	152
FE lock.....	85
Flash exposure compensation....	75
Flash metering mode	105
Flash off.....	48
Red-eye corr. (printing).....	135
Red-eye reduction	55
Shutter speed fixed	
at 1/200 sec.	104
Flash exposure compensation	75
1/2-stop increments	105
Focus lock	42
Focus mode switch	30, 58

Focusing

AF mode	56
AF point selection	57
AF-assist beam	41
Beeper	94
Blur.....	33, 41, 58
Difficult-to-focus subjects	160
Manual focusing.....	58
Recompose.....	42
Folder	96
Format (CF card initialization)	38
Full Auto	40
Function Availability Table	158

H

Highlight alert	124
Histogram	125
Brightness / RGB	

I

Image	
Auto playback	120
Auto rotate	98
Erase.....	123
Histogram.....	125
Image review time	94
Transfer to personal computer ...	107
Index display	116
Jump display	117
Magnified view	118
Manual rotate	119
Playback	50, 115
Protect.....	122
Shooting information	124
View on TV.....	121
Image conversion factor	172
Image dust prevention.....	111, 112
Image review time	94

- Image transfer..... 107
- Image Zone..... 20
- Index display..... 116
- ISO speed..... 53
- J**
- Jump display..... 117
- L**
- Landscape 44, 63
- Language selection..... 37
- LCD monitor..... 13, 34, 162
- Auto off 101
- Brightness adjustment..... 95
- Camera setting screen 18, 34
- Image playback 50, 115
- Menu screen..... 35, 156
- Lens 16, 30
- Level adjustment (printing) 136
- Long exposures → Bulb exposures
- M**
- M (Manual exposure)..... 71
- Magnified view 106, 118
- Malfunction 161
- Manual exposure 71
- Manual focusing..... 58, 160
- Maximum burst 61
- Memory card → CF card
- Menu
- Menu settings 156
- Setting operation 36
- MENU** icon 4
- Metering mode..... 73
- Evaluative / partial / center-weighted average metering
- MF (Manual focusing)..... 58
- Mirror lockup 91, 105
- Mode Dial → Shooting mode
- Monochrome photo 64, 80, 134
- N**
- Natural/M (printing) 134
- Neutral..... 63
- Night Portrait 47
- Noise reduction 71, 103
- Nomenclature..... 16
- Number → File number
- O**
- One-Shot AF 56
- P**
- P (Program AE)..... 52
- Paper settings (printing) 132
- Partial metering 73
- Personal computer
- Image transfer..... 107
- Wallpaper 109
- PictBridge..... 127
- Picture Style
- Adjustment..... 78
- Selection 63
- User defined 81
- Pixel count selection 60
- Playback → Image
- Portrait..... 43, 47, 63
- Power
- Auto power off..... 95
- Battery check 26
- Household power outlet..... 154
- Possible shots..... 27
- Recharge 24
- Switch 31

- Printing..... 127
 CP/BJ Direct..... 139
 Paper settings..... 133
 PictBridge..... 132
 Print order (DPOF)..... 144
 Print/Share button..... 108, 143
 Printing effects..... 134
 Trimming..... 142
 Program AE..... 52
 Program shift..... 52
 Protect (image erase-protection)..... 122
- R**
- RAW..... 62
 RAW+JPEG..... 62
 Recharge..... 24
 Recording quality selection..... 60
 Red-eye reduction..... 55
 Remote control..... 90, 153
 Reset to default..... 100, 102
 Rotate (image)..... 98, 119
- S**
- Saturation..... 79, 135
 Self-timer..... 49
 Shutter release
 after 2-sec. delay..... 91
 Sensor cleaning..... 111
 Sepia (Monochrome)..... 80
 Servo AF..... 42, 56
 Sharpness..... 79
 Shoot w/o card..... 94
 Shooting information display..... 124
 Shooting mode..... 20
 A-DEP..... 72
 Aperture-priority AE..... 68
 Close-up..... 45
 Flash off..... 48
 Full Auto..... 40
 Landscape..... 44
 Manual exposure..... 71
 Night Portrait..... 47
 Portrait..... 43
 Program AE..... 52
 Shutter-priority AE..... 66
 Sports..... 46
 Shots remaining..... 27, 61
 Shutter button..... 33
 Shutter-priority AE..... 66
 Sports..... 46
 Strap..... 22
 System Map..... 164
- T**
- Toning effect (Monochrome)..... 80
 Sepia / Blue / Purple / Green
 Transfer order (image)..... 109
 Trimming (printing)..... 142
 Tv (Shutter-priority AE)..... 66
- V**
- View on TV..... 121
 Video OUT (NTSC/PAL)... 121, 157
 Viewfinder..... 19
 Dioptric adjustment..... 31
- W**
- Warm tone (printing)..... 134
 WB → White balance
 White balance..... 86
 Custom white balance..... 86
 White balance bracketing..... 89
 White balance correction..... 88
 Wireless remote control..... 90, 153



CANON INC. 30-2, Shimomaruko 3-chome, Ohta-ku, Tokyo 146-8501, Japan

U.S.A. ————— **CANON U.S.A. INC.**

One Canon Plaza, Lake Success, NY 11042-1198, U.S.A.
For all inquiries concerning this product, call toll free in the U.S.
1-800-OK-CANON

CANADA ————— **CANON CANADA INC. HEADQUARTERS**

6390 Dixie Road, Mississauga, Ontario L5T 1P7, Canada
CANON CANADA INC. MONTREAL BRANCH
5990, Côte-de-Liesse, Montréal Québec H4T 1V7, Canada
CANON CANADA INC. CALGARY OFFICE
2828, 16th Street, N.E. Calgary, Alberta T2E 7K7, Canada
For all inquiries concerning this product, call toll free in Canada
1-800-OK-CANON

EUROPE, ————— **CANON EUROPA N.V.**

AFRICA & Bovenkerkerweg 59-61, P.O. Box 2262, 1180 EG Amstelveen, The Netherlands

MIDDLE EAST **CANON COMMUNICATION & IMAGE FRANCE S.A.S.**

12 Rue de l'Industrie 92414 Courbevoie Cedex, France

CANON UK LTD.

Woodhatch Reigate Surrey RH2 8BF, United Kingdom

CANON DEUTSCHLAND GmbH

Europark Fichtenhain A10, 47807 Krefeld, Germany

CANON ITALIA S.p.A.

Via Milano 8 I-20097 San Donato Milanese, Milano, Italy

CANON Schweiz AG

Geschäftsbereich Wiederverkauf, Industriestrasse 12, CH-8305 Dietlikon, Switzerland

CANON GMBH

Zetschegasse 11, A-1230 Wien, Austria

CANON España, S. A.

C/Joaquín Costa, 41, 28002 Madrid, Spain

SEQUE Soc. Nac. de Equip., Lda.,

Praça da Alegria, 58, 2º, 1269-149 Lisboa, Portugal

CENTRAL & ————— **CANON LATIN AMERICA, INC.**

SOUTH AMERICA 703 Waterford Way, Ste. 400 Miami, FL 33126, U.S.A.

ASIA ————— **CANON (China) Co., Ltd.**

15F Jinbao Building No.89 Jinbao Street, Dongcheng District, Beijing 100005, China

CANON HONGKONG CO., LTD.

19/F., The Metropolis Tower, 10 Metropolis Drive, Hunghom, Kowloon, Hong Kong

CANON SINGAPORE PTE. LTD.

1 HarbourFront Avenue, #04-01 Keppel Bay Tower, Singapore 098632

CANON KOREA CONSUMER IMAGING INC.

Startower Bldg.17F,737, Yeoksam-Dong, Kangnam-Ku, Seoul, 135-984, Korea

OCEANIA ————— **CANON AUSTRALIA PTY. LTD.**

1 Thomas Holt Drive, North Ryde, N.S.W. 2113, Australia

CANON NEW ZEALAND LTD.

Akoranga Business Park, Akoranga Drive, Northcote, Auckland, New Zealand

JAPAN ————— **CANON MARKETING JAPAN INC.**

16-6, Kohnan 2-chome, Minato-ku, Tokyo 108-8011, Japan

This Instruction Manual booklet is current as of August 2006. For information on the camera's compatibility with any accessories and lenses introduced after this date, contact any Canon Service Center.